

8-2016

Asbestos Cement Pipe Condition Assessment and Remaining Service Life Prediction

Abiy Melles Ghirmay
University of Arkansas, Fayetteville

Follow this and additional works at: <http://scholarworks.uark.edu/etd>

 Part of the [Hydraulic Engineering Commons](#), and the [Water Resource Management Commons](#)

Recommended Citation

Ghirmay, Abiy Melles, "Asbestos Cement Pipe Condition Assessment and Remaining Service Life Prediction" (2016). *Theses and Dissertations*. 1744.

<http://scholarworks.uark.edu/etd/1744>

This Thesis is brought to you for free and open access by ScholarWorks@UARK. It has been accepted for inclusion in Theses and Dissertations by an authorized administrator of ScholarWorks@UARK. For more information, please contact scholar@uark.edu, ccmiddle@uark.edu.

Asbestos Cement Pipe Condition Assessment and Remaining Service Life Prediction

A thesis submitted in partial fulfillment
of the requirements for the degree of
Master of Science in Civil Engineering

by

Abiy Ghirmay
University of Arkansas
Bachelor of Science in Civil Engineering, 2014

August 2016
University of Arkansas

This thesis is approved for recommendation to the Graduate Council.

Dr. Clinton Wood
Thesis Director

Dr. Julian Fairey
Committee Member

Dr. Michelle Bernhardt
Committee Member

Abstract

This research details a condition assessment of asbestos cement (AC) pipe within in the Bella Vista Village Property Owners Association water distribution system. Bella Vista Village contains appropriately 300 miles of AC pipe with nominal diameters from 6-14 inch installed in the 70s and early 80s. The goal of the research is to determine the current condition of AC pipe within the system and predict future performance of the pipes. AC pipe samples were obtained from 23 locations spread out across the distribution system with nominal pipe diameters of 6-8 inch. Estimates of current level of degradation were obtained using phenolphthalein staining and hardness measurements of each sample. The residual strength of the pipes was measured using ASTM standard tests for pipe strength, such as crushing and hydrostatic tests. Remaining life of the AC pipe was estimated based on a linear degradation rate determined appropriate from a number of accelerated acid degradation experiments. These accelerated acid experiments conclusively determined the shape of the degradation vs time plot was linear.

The AC pipe samples tested in the research were determined to be minimally to moderately degraded, with degradation levels measured between 1-31%. However, over 60% of the samples were determined to be below 10% degradation. All samples tested above AWWA strength requirements for crushing and hydrostatic capacity for AC pressure pipes. The estimated remaining service life for the AC pipe samples varied from 1 to >100 years with the majority (54%) of the samples having an estimated remaining service life greater than 100 years.

Table of Contents

1	Introduction.....	1
2	Literature Review.....	4
2.1	Introduction	4
2.2	Manufacturing and Chemical Composition of Asbestos Cement Pipe	5
2.3	AC Pipe Degradation.....	7
2.3.1	Internal Pipe Degradation.....	7
2.3.2	External pipe deterioration	9
2.3.3	Failure Mechanisms	10
2.4	Testing Methods	11
2.5	Visual Inspection	12
2.6	Hardness Test	12
2.7	Phenolphthalein Staining Test.....	12
2.8	Crushing Test	13
2.9	Hydrostatic Pressure Test.....	14
2.9.1	Minimally Intrusive Condition Assessment Techniques.....	14
2.9.2	Accelerated Acid Degradation	15
2.10	Rate of Degradation.....	16
2.11	Results from Specific Literature.....	18
2.12	Conclusion.....	28

3	Asbestos Cement Pipe Evaluation	29
3.1	Introduction	29
3.2	Sample Collection	30
3.3	Condition evaluation methods.....	34
3.3.1	Non-Destructive Testing	34
3.3.2	Destructive Testing:	39
3.4	Conclusion.....	45
4	Accelerated Acid Degradation.....	47
4.1	Introduction	47
4.2	Accelerated Acid degradation testing schedule.....	48
4.2.1	Phase I Acid testing procedure.....	48
4.2.2	Phase II Acid Testing Procedure	50
4.2.3	Phase III Acid Testing Procedure.....	52
4.3	Full Scale Acid Testing	54
4.4	Conclusion.....	57
5	Condition Assessment Results.....	59
5.1	Introduction	59
5.2	Non-Destructive Testing	59
5.2.1	Visual Inspection and Observations	59
5.2.2	Phenolphthalein Staining.....	61

5.2.3	Hardness test.....	69
5.3	Destructive Testing.....	71
5.3.1	Crushing strength	71
5.3.2	Hydrostatic strength	78
5.3.3	Conclusion.....	84
6	Rate of AC Pipe Degradation	85
6.1	Introduction	85
6.2	Results from Phase I, II and III of Acid Testing	85
6.3	Conclusion.....	93
7	Future Life Prediction for AC Pressure Pipes.....	94
7.1	Introduction	94
7.2	Remaining service life using a linear relationship	94
7.3	Conclusion.....	99
8	Conclusion	100
9	Future Work.....	106
9.1	For Bella Vista Village Property Owner’s Association	106
9.2	General Asbestos Cement Pipe Research.....	106
10	Works Cited	107

Table of Figures

Figure 2-1. Microscopic image of surface of crushed sample, Mai (1979).....	10
Figure 2-2. Comparison of Phenolphthalein degradation measurement vs scanning electron microscopy, (Mordak and Wheeler 1988)	13
Figure 2-3. Correlation between crushing test and level of degradation from Hu et al., 2013.....	19
Figure 2-4. Crushing load vs Degradation from Mordak and Wheeler (1988)	26
Figure 3-1. Map of BVVPOA showing AC water mains	29
Figure 3-2. Sampling locations from Bella Vista	30
Figure 3-3. AC pipe sampling procedure.....	31
Figure 3-4. a) Surface before grinding; b) Measuring the pipe thickness after grinding.....	36
Figure 3-5. Phenolphthalein staining of AC pipe surface.....	37
Figure 3-6. Measurement of Hardness using the Shore D Durometer device	39
Figure 3-7. Crushing test configuration per ASTM C500 (2011)	40
Figure 3-8. Picking failure load on sample crushing test data.....	41
Figure 3-9. Crushed sample with cracks highlighted.....	42
Figure 3-10. Crushing Test repeated for samples from same location	42
Figure 3-11. Hydrostatic test set up	44
Figure 3-12. Hydrostatic test load build up and failure point	45
Figure 4-1. Plastidip protected sample after acid degradation.....	49
Figure 4-2. Phase I Acid Test set up	49
Figure 4-3. a) Sample set up for Phase II b) Ion Chromatograph.....	52
Figure 4-4. Phase III acid test steps	54
Figure 5-1. Sample 10B depicting the external surface of AC pipe	60

Figure 5-2. Surface showing no internal degradation and localized external degradation	62
Figure 5-3. Sample with gradient between degraded and non-degraded front	66
Figure 5-4. Comparison between Manual and Matlab degradation measurements	66
Figure 5-5. Sampling locations with highlighted levels of degradation	68
Figure 5-6. Degradation level distribution among sampling locations	69
Figure 5-7. Shore D Durometer Test on degraded (left) and non-degraded (right) samples	70
Figure 5-8. Factor of Safety against crushing for all tested samples	72
Figure 5-9. Crushing load vs degradation with AWWA requirement shown.....	73
Figure 5-10. Rupture Modulus calculated from crushing load plotted against degradation.....	74
Figure 5-11. Rupture Modulus values from samples taken from BVVPOA and Hu et al. (2013) report along with the 95th percentile AWWA intersection shown.....	75
Figure 5-12. Sample with external degradation compared with sample with degradation on both sides.....	77
Figure 5-13. Hydrostatic Pressure values for all tested samples (6" and 8").....	79
Figure 5-14. Bar graph depicting the factor of safety for hydrostatically tested samples	80
Figure 5-15. Tensile strength calculated from hydrostatic data which accounts for differences in pipe thickness and diameter	81
Figure 5-16. Tensile strength from Hu et al. (2013) and Bella Vista with AWWA and 95th percentile intersection shown.....	82
Figure 6-1. Rate of degradation from Phase I acid testing	86
Figure 6-2. Change in degradation at 7 days shown for Phase I samples.....	87
Figure 6-3. Cation measurement to determine level of degradation for Phase II of acid test	88
Figure 6-4. Phase III Calcium and Magnesium ion levels.....	90

Figure 6-5. Phase III acid test results showing linear rate of degradation for all dilutions	92
Figure 7-1. Degradation rate, inches/year for samples from BVVPOA	95
Figure 7-2. Degradation vs Time plot for remaining service life calculation.....	96
Figure 7-3. Bar graph depicting the distribution of remaining service life across the utility	97

List of Tables

Table 3-1. Summary of AC pipe samples collected for the project.....	33
Table 5-1. Phenolphthalein staining results from all sampled locations	63
Table 5-2. Summary table of collected samples and test results.	83
Table 6-1. Correlation between leached calcium and magnesium to increase in degradation	91
Table 7-1. Tabulated results of remaining service life	97
Table 7-2. Remaining service life considering various controlling scenarios	98
Table 8-1. Summary of results from tested locations	104
Table 8-2. Remaining service life for sampled locations	105

1 Introduction

Asbestos has physical and chemical properties that make it virtually indestructible, making it a popular building material in the middle of the 20th century. Although it was later found that asbestos fibers can form clumps in the lung leading to Mesothelioma, there was already a significant amount of asbestos used for different applications across the US. Asbestos Cement pipes (AC) were installed throughout the US as a substitute for rusting cast iron pipes. Williams and Aspern (2010) estimate that AC pipe makes up 12 to 15% of water mains in the United States. AC pipe degrades as a result of chemical reactions with its environment. Two deterioration processes typically occur to AC pipe: lime leaching and sulfate attack. The free lime formed during hydration maintains the strength of the cement matrix, but free lime can be leached from the cement by water in contact with the pipe surface. Sulfate contained in the conveyed water and in the soil pore water (groundwater) can also react with hydrated calcium aluminate creating ettringite that expands and leads to the destruction of the cementitious portion of AC pipe. There have been various efforts by water utilities across the country to identify the extent of degradation in the AC water pipes. This effort is restricted to specific utilities and due to the variability of soil condition pipes are buried under, the results cannot be applied to other utilities.

The Bella Vista Village Property Owner's Association (BVVPOA) was concerned with its aging AC pipe infrastructure. There is approximately 311 miles of AC water line in the utility's system. BVVPOA approached the University of Arkansas to assess the condition of the AC water system. The scope of this research includes determining the extent of degradation in the AC water lines, and estimating the remaining service life for the AC pipes. Determining the level of degradation includes both destructive and non-destructive techniques. The destructive

techniques which are crushing and hydrostatic testing allow for measurement of residual strength. The non-destructive testing which include visual inspection, phenolphthalein staining, and hardness test allow measurement of the extent of AC pipe softening due to lime leaching which is the process by which AC pipe degrades. Remaining service life was estimated using results obtained from accelerated acid testing that provided understanding of the shape of the rate of degradation plot.

Crushing test was performed on one foot sections of pipe that were sampled from BVVPOA using a 20,000 lb capacity MTS machine. There were also Four foot sections of AC pipe delivered from the utility that were hydrostatically tested for bursting pressure. The non-destructive tests were performed prior to the crushing and hydrostatic tests. Visual inspection included identification of any obvious gouges or anomalies that could affect the residual strength measurements or chemical deposits on the surface of the pipe that affect the rate of degradation. Phenolphthalein staining was performed on all AC pipe samples to acquire the level of degradation on the samples prior to destructive testing. The hardness test was performed to confirm the results from phenolphthalein staining tests. The accelerated acid testing program was divided into two portions. The first portion aimed at identifying the shape of the rate of degradation by inserting 3” by 3” AC pipe coupons cut out from one foot samples into acid baths of different strength and monitoring the degradation. The second portion was full scale testing on one foot and four foot pipes to compare results from acid degraded pipes and pipes degraded in the soil while in service. The second portion also allowed for acquiring residual strength data for pipes with high levels of degradation that were not observed in-situ.

This report is divided into 9 chapters. The first Introduction chapter details the motivation and scope for the research conducted. Chapter 2 is the Literature Review where a comprehensive

study is detailed into the work done on Asbestos Cement pipes to date. The review includes summaries of the various methods used by researchers and utilities to assess AC water mains. Chapter 3 details the methods used to obtain the current condition of AC pipe. These methods include non-destructive (visual inspection, phenolphthalein staining, and hardness), and destructive (crushing and hydrostatic). Chapter 4 follows up on the work from the previous chapter and details the method for remaining service life assessment using accelerated acid testing. The results from Chapter 3 are detailed in Chapter 5. Chapter 6 details results from the accelerated acid degradation that show the shape of the rate of degradation. Chapter 7 is a continuation of Chapter 6 which specifically outlines the remaining service life for AC pipes in BVVPOA. Chapter 8 details all the conclusion results from this paper. Chapter 9 is the final chapter which is a future works chapter that lays the ground work for further research that could allow an even broader understanding of AC pipe degradation.

2 Literature Review

2.1 Introduction

Asbestos is a generic term used to describe families of minerals, namely the serperntines and the amphiboles, which occur naturally as fiber bundles (Fisher and Morchat 1993). The minerals that form asbestos are not easily destroyed due to their physical and chemical properties. For this reason, asbestos was widely used as a raw material for roofing products, water pipes, fireproofing, and insulation. However, the inhalation of asbestos fibers was later identified as a primary cause of mesothelioma and other types of lung cancers, which halted its use in construction materials in the US in the 1980s.

Asbestos Cement (AC) is a mixture of asbestos fibers, which act as a reinforcing element, and cement paste, which acts as a binding agent. During the early 20th century, problems with rust formation in galvanized steel led to the exploration of other materials for pipe manufacturing. Between 1906 and 1913, a Genoa company combined asbestos fibers with cement to produce a reinforced pipe that would take the high pressure necessary to pump salt water used for street flushing. It was first introduced in North America in 1929 when Johns-Manville Corporation installed an AC pipe manufacturing machine (Hu et al. 2013). AC pipe was installed throughout the world from 1920 to the early 1980s and its use became widespread in the US during the 1950's and 1960's, particularly in the smaller diameter distribution sizes (Mordak and Wheeler 1988). National Academy of Sciences (1982) estimates that, since the development of asbestos cement (AC) pipes approximately 100 years ago, the total length of AC pipelines in service is approximately 2.4 million kilometers worldwide. AC pipe is currently estimated to make up 12 to 15% of water mains in the United States (Williams and Aspern 2010). While it may seem concerning that up to 15% of water mains are composed of asbestos

cement, the health dangers are very minimal. The cancer causing nature of asbestos stems from inhalation and not ingestion of asbestos fibers, which form clusters in the lung. Hu et al. (2009) showed that asbestos cement water pipes are generally non-friable (i.e., cannot be crushed by hand pressure once the cement is set), therefore exposure to AC pipe in service is generally not a health risk. The United States Environmental Protection Agency (U.S. EPA), has a public health goal which limits the amount of fibers in drinking water to less than 7 million fibers per liter for asbestos fibers exceeding 10 micrometer in length (Sullivan et al. 2003). The asbestos fibers released from AC pipe degradation have been shown to fall well below this criterion (Bracken, 2012). Care must be taken however, when replacing or rehabilitating AC pipes, since the disturbance associated with excavating and cutting out pipes can cause aerosol asbestos release.

2.2 Manufacturing and Chemical Composition of Asbestos Cement Pipe

The first AC pipes produced in the US were considered to be Type I. Type I AC pipes contain 20% asbestos fiber and 80% Portland cement cured under moist conditions. Most AC pipes in the US were installed after the transition to Type 2 steam autoclaved AC pipe, which occurred in the 1940s. Type II steam autoclaved AC pipes differ from Type I AC pipes in that, 40% of the cement was replaced with silica that bonded with the free lime producing a more stable product since it permitted for various hydrothermal reactions in addition to the hydrolysis of cement (Bracken 2012; Hu et al. 2013). Type II AC pipes manufactured in North America were made using 15-20% of asbestos, 45-51% of Portland cement, 32-34% of quartz (which contains mainly silicon oxide), and contained less than 1% of free lime (Nebesar and Riley 1983).

The U.S. federal standard SS-P-531 was developed in 1940 to regulate the manufacture of AC pipe. This was followed by the AWWA C400-53T standard, which covered pressure classes

100, 150, and 200, and detailed general requirements regarding such things as materials of manufacture, pipe sizes and markings (Hu et al. 2013). Several revisions to this standard have since been developed incorporating minimum strength requirements, sulfate resistance, use of silica, and autoclave curing. Hu et al. (2013) highlight the production of AC pipe using the Mazza process in their report for the Water Research Foundation as follows:

- Asbestos fibers and other dry ingredients (Portland cement, silica powder) are first blended together, then mixed with water to produce a slurry in which the fibers become thoroughly coated.
- The slurry is deposited in a thin layer on a continuous felt conveyor, which passes between rollers and over vacuum boxes that remove excess water from the mixture, producing a viscous layer of AC paste approximately 0.2 mm in thickness.
- The paste layer then contacts a revolving steel mandrel, onto which the paste is wound and densely compacted by high-pressure forming rollers. Accurately machined mandrels are available for each diameter of pipe being manufactured, with the outside face of the mandrel corresponding to the inner surface of the pipe.
- The process continues, under gradually reducing pressure, until a pipe of the required thickness is produced.
- The pipe is then removed from the machine and cured using either normal (emersion in water or warm saturated air) or autoclave curing methods, depending on the ingredients being used (i.e., Type I or Type II).
- The pipe is machined and labeled, then sent for a variety of quality control tests prior to being released for sale and distribution.

2.3 AC Pipe Degradation

AC pipes are made of porous cementitious, Calcium Silica Hydrate (C-S-H), matrix that binds the asbestos fibers together. Deterioration (degradation) of AC is generally caused by either soft water leaching of the cementitious matrix, or by acid or sulfate attack. When in contact with soft water, the free lime formed during the cement hydration process can be dissolved and travels through the pores of the matrix. With continuous exposure, the free lime continues to exit the matrix creating larger pores. During this process of free lime leaching, carbonation may also occur. As the calcium hydroxide (Ca(OH)_2) is strongly alkaline in nature, it can quickly react with dissolved CO_2 in pore water to form calcium carbonate (calcite (CaCO_3)), which effectively reduces the pH value of the pore water solution from greater than 12.4 to around 9.0. As the pH continues to decline, calcite becomes more soluble, and leaves the cement matrix (Wang et al. 2011). The continuous removal of free lime and calcite leads to the formation of a soft AC matrix, which can no longer bind the asbestos fibers together. The formation of soft AC is conventionally termed as deterioration or degradation of AC pipe, which eventually leads to failure.

The conditions that lead to the formation of soft AC may be present in the conveyed water (internal degradation) or the surrounding soil (external degradation). Nebesar and Riley (1983) and Jarvis (1988) identified acids, sulfates, magnesium salts, alkaline hydroxides, ammonia, pH, and soft water as primary compounds and attributes that drive degradation.

2.3.1 Internal Pipe Degradation

Internal degradation of AC pipe is linked to the aggressiveness of the water being transported. Hu et al. (2013) show that low alkalinity water, below 60mg/L as CaCO_3 is detrimental to AC pipes. If the water is aggressive, lime leaching will occur, which releases

asbestos fibers into the water system. Various attempts have been made to classify the aggressiveness of various conveyed waters to AC pipe. The two most commonly used parameters are the Langelier Index, which is a measure of the level of carbonate saturation, and the AWWA Aggressiveness Index, which is a simplification of the Langelier Index (Mordak and Wheeler 1988). These indices are based on a measure of the calcium carbonate content of water relative to its pH. These indices indicate whether conveyed water has a tendency to form or dissolve calcium carbonate scale. The Langelier index is defined as: $LI = pH - pH_s$, where pH_s is the pH value at which water is saturated with calcium carbonate [$pH_s = 12.3 - (\log C + \log A + 0.025T - 0.011 \cdot \sqrt{S})$], C is calcium hardness mg/L, A is total alkalinity mg/L, T is temperature in Celsius, and S is total dissolved solids mg/L]. Water with negative LI value is considered aggressive to AC pipe (White, 1985). The AWWA Aggressiveness Index (AI) is modified to account for temperature dependence of the solubility of calcite, and the ionic strength of the solution. AI is defined as $AI = pH + \log([A] \cdot [H])$, where A is the alkalinity expressed as mg/L of $CaCO_3$, and H is the hardness expressed as mg/L of $CaCO_3$. $AI < 10.0$ is considered highly aggressive, $10.0 < AI < 11.9$ is considered moderately aggressive, and $AI > 12$ is considered non-aggressive (White, 1985).

Although it is not desired for asbestos fibers to enter the water system, research has showed that no adverse health effects has been caused by drinking small doses of asbestos fibers found in the conveyed water (Fawell 2002). Therefore, the main adverse effect of aggressive conveyed waters in AC pipe is strength loss associated with pipe degradation. The level of pipe degradation due to conveyed water is assumed to be uniform throughout the utility, since the conveyed water composition doesn't change significantly within a utility. However, this assumption has been found to be false since various other factors affect the level of internal

degradation (Hu et al. 2013; Chowdhury et al. 2012; Mordak and Wheeler 1988). Operating conditions such as working pressure, and initial manufacturing variations in AC pipe have been shown to influence the level of degradation (Chowdhury et al. 2012).

2.3.2 External pipe deterioration

External degradation of AC pipe is caused by the chemicals in the surrounding soil attacking the outer wall of the pipe. The two common methods of degradation for AC pipe in contact with the environment is lime leaching and sulfate attack (Hu et al. 2013). Sulfates occur naturally in certain soils especially those with high organic content. Sulfate attack, which can be a problem for typical Portland Cement Concrete, reacts with the free lime in the cementitious matrix, resulting in the leaching out of lime. In addition to this, sulfate can react with hydrated calcium aluminate to form calcium sulphoaluminate, also known as ettringite. The formed ettringite occupies 123 - 224% more volume than the original solids it replaces (Hu et al. 2013). This expansion can weaken the AC structure. The leaching of lime from the cement matrix can also increase the porosity of the cement matrix while the silica hydrate products (ettringite) can expand in the cement matrix, ultimately reducing the strength of the pipe. Variations in soil pH, sulfate content, and water level can affect the rate of degradation on the outer surface of the pipe, resulting in variable cement leaching rates from one location to another and even around the cross section of individual pipe sections. These variations result in difficulty in modeling the rate of AC pipe degradation. Since both lime leaching and sulfate attack require aqueous solutions, it is understood that the level of ground saturation plays an important role in the extent of deterioration experienced by the AC pipe. Existence of a water table above the depth of pipe burial, coupled with an aggressive environment can accelerate AC pipe degradation.

2.3.3 Failure Mechanisms

The combination of internal and external degradation causes a reduction in the structural integrity of the pipe cross section, which could eventually lead to failure. Soft AC is generally considered to have lost a considerable amount of its initial binding strength. Ultimate pipe failure occurs through the pull out of the asbestos fiber from the cement matrix that is no longer strong enough to hold the fibers together. This assumption is verified by images from microscopic examination of fracture surfaces which show little sign of fiber breakage, as shown in Figure 2-1 (Mai 1979).

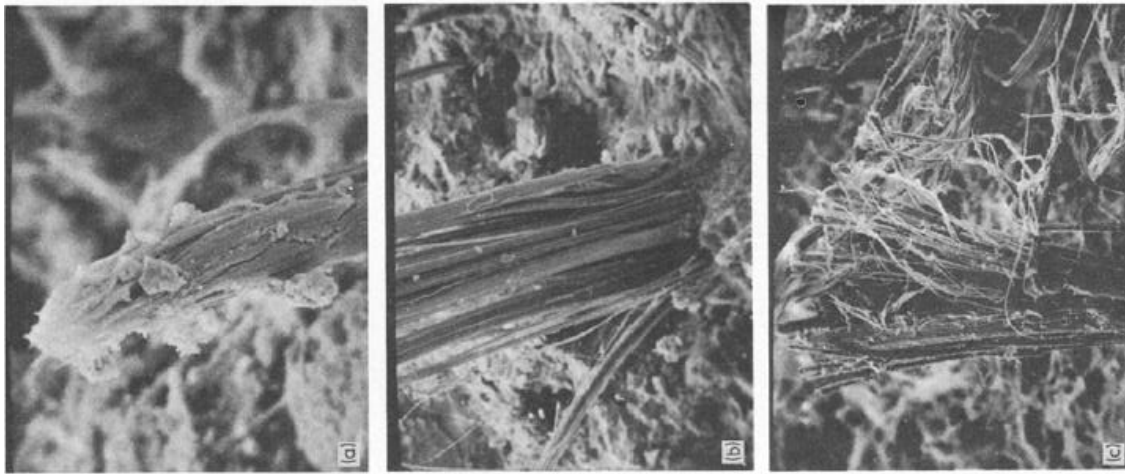

Figure 2-1. Microscopic image of surface of crushed sample, Mai (1979)

Factors that lead to failure of water mains can be grouped into three general categories: a) physical characteristics of the pipes themselves (strength and modulus of elasticity); b) the environments in which the pipes were installed (climate, soil type, and groundwater properties); c) operational characteristics (conveyed water quality and procedures for operation, maintenance, repair, and replacement) (Hu and Hubble 2007).

a) Physical Characteristics of the pipe

Most utilities installed AC pipe manufactured by a single company, therefore for a given utility the physical characteristics of the pipes are assumed to be very similar. Although this

assumption could be incorrect, there is no feasible method to account for the chemical variation of in-service AC pipe manufactured by the same company.

b) The environments in which the pipes were installed

The environment in which the pipes are installed is considered to be the primary factor that influence the rate of external AC pipe degradation. It has been shown that ground water, sulfate content, and lime leaching chemicals in the environment affect the extent of external degradation. As AC pipe is further degraded, the likelihood of failure increases.

c) Operational characteristics

While operation procedures, maintenance, repair and replacement can influence the rate of failure of AC pipe, conveyed water quality is the primary factor that leads to internal AC pipe degradation. Aggressive water has the capability to leach calcium out of the cement matrix, which leads to loss of strength in the AC pipe ultimately leading to failure.

2.4 Testing Methods

AC pipe has been shown to degrade both internally and externally through either aggressive conveyed water or the environment in which it's buried. It is therefore, necessary to incorporate testing methods that can adequately measure the level of both internal and external degradation. While the physical methods employed for measuring the level of degradation in the internal and external portion of AC pipe, discussed in detail next, are similar, there are separate techniques for assessing internal and external environment's capability to attack AC pipe. Such methods for internal environment analysis include calcium carbonate saturation analysis and water quality testing while, external environment analysis includes soil/geological mapping, soil corrosively mapping, and soil tests (Hu et al. 2013). These chemical tests assess the environment's capability to degrade the AC pipe but, do not measure the current level of

degradation. Therefore, these methods are not discussed further and the focus is on methods which allow for the measurement of level of AC pipe degradation. These methods can be grouped into destructive and non-destructive. Non-destructive testing includes visual inspection, phenolphthalein staining, and hardness testing; while destructive testing includes, crushing, and hydrostatic testing.

2.5 Visual Inspection

The visual inspection of AC pipes is the first round of inspection that helps identify visible damage in the AC pipe. Visual inspection can highlight such factors like reddish iron deposit, sulfur attack, manufacture defects, large gouges and similar physical anomalies that are visible to the naked eye. This measurement is qualitative, meaning words are used to describe the condition of the pipe. The qualitative nature of this test means it's highly subjective to the person conducting the test.

2.6 Hardness Test

To improve on the qualitative description acquired using visual observation, the hardness test is performed. This test is conducted using a Shore D durometer instrument which measures hardness. This device provides a relative hardness value meaning the hardness number cannot be correlated to a strength value. However, it can serve as a comparison tool between hardness of different pipe surfaces. This test also provides a numerical value that can explain the level of softening occurring in the degraded AC.

2.7 Phenolphthalein Staining Test

Phenolphthalein solution is used to differentiate the degraded portion of the pipe from the non-degraded portion (i.e., the portions of the pipe where lime has been leached away versus portions which still contain lime). If the pH of the material is higher than 9.5, the asbestos

cement turns purple. Similarly if the pH is lower than 9.5, the asbestos cement remains colorless (i.e., remains the gray AC color, indicating lime has been leached out (Slaats et al. 2004)). The simplicity of this test has made it a popular method of acquiring degradation levels. Mordak and Wheler (1988) showed that phenolphthalein is a viable method by comparing it to scanning electron microscopy as shown in Figure 2-2. The scanning electron microscopy is a method widely used and considered to provide more accurate values, since it allows for examination of the pipe cross-section in detail. The results of the phenolphthalein testing in Figure 2-2 match relatively well across a full range of degradation values illustrating the accuracy of Phenolphthalein staining.

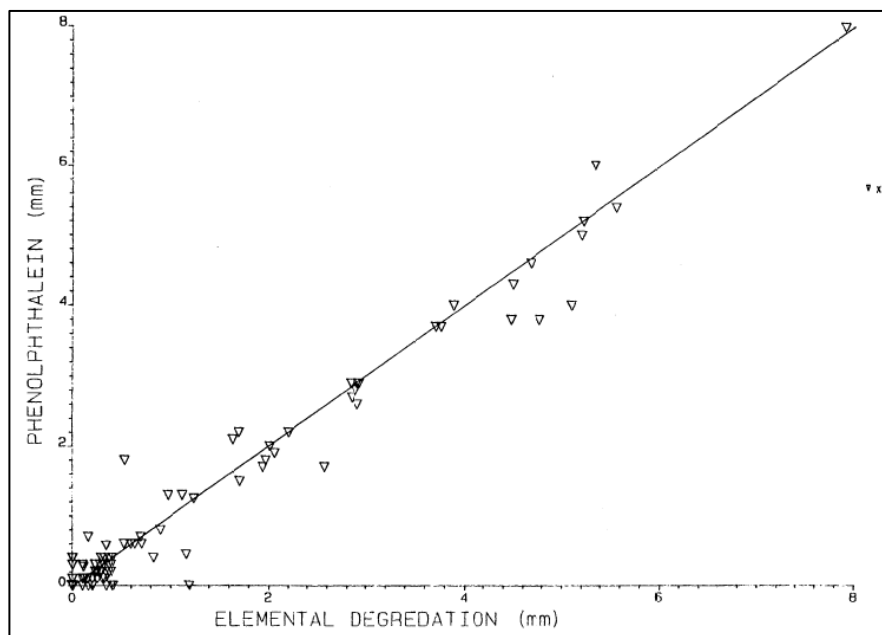

Figure 2-2. Comparison of Phenolphthalein degradation measurement vs scanning electron microscopy, (Mordak and Wheeler 1988)

2.8 Crushing Test

While acquiring the extent of degradation experienced by AC pipe through phenolphthalein staining is critical, it has to be complemented with knowledge of the residual strength of the pipe. Crushing test provides AC pipe strength values at the level of degradation

being experienced by the sample. The crushing test establishes the current level of strength, which can be compared to the crushing loads stated in the AWWA C400-03 specifications and also used to establish correlations with level of degradation.

2.9 Hydrostatic Pressure Test

Hydrostatic pressure test is a measure of the resistance provided by the AC pipe to the buildup of internal pressure. Similarly to the crushing test, hydrostatic test provides residual strength value of AC pipes at the degradation level being tested. ASTM C500 details the testing procedures to be followed for AC pipes.

2.9.1 Minimally Intrusive Condition Assessment Techniques

The destructive and non-destructive tests mentioned above, which both require sampling, might not be feasible in all situations. For utilities located in heavily populated areas, sampling might be of greater difficulty due to the number of customers that will be without water, and also the cost of excavating samples from concrete and asphalt surfaces may be too costly. Techniques such as Geo-radar, and acoustic testing have been developed to assess AC pipe in these situations. Slaats et al. (2004) show a considerable correlation between degradation measured using phenolphthalein and geo-radar technique. Georadar test gives information on the stratification of the AC pipe wall. This stratification information is an average value, therefore, Slaats et al. (2004) suggest that sampling be conducted where possible to check the applicability of geo-radar method.

Acoustic velocity measurements provide an average structural stiffness for the AC pipe (Bracken et al. 2011). The accuracy of the test is limited by the spacing of the sensors and the lack of work on AC pipe which makes it difficult to accurately model the level of degradation. This is because the degraded portion of AC pipe is still capable of supporting load (Harris and

Radlinski 2012), even if the measured velocities indicate less structural stiffness. When feasible, sampling techniques are considered the best method for AC pipe condition evaluation. However, non-intrusive methods such as geo-radar and acoustic velocity measurement techniques can serve to provide an estimate of the AC pipe condition. While these methods can serve as substitutes in certain situations, they can only provide average values across the length of pipe being tested, and are also unable to identify the level of strength loss in the AC pipe. For these reasons geo-radar and acoustic techniques are not further explored in this research.

2.9.2 Accelerated Acid Degradation

AC pipe degrades over a period of several decades. It is generally not feasible to monitor the levels of degradation throughout the lifespan of the pipe. It is therefore necessary to come up with a method to regulate and monitor the rate of degradation, rate of strength loss as a function of degradation and the chemical changes that occur during the process of degradation. One of the first controlled AC pipe degradation experiments was conducted by Denison and Romanoff (1951). They buried 10, 6-in AC pipe samples at each of 15 test sites with different soil properties and sampled for a period of 13 years. Their results showed that no significant reduction of strength had occurred even under the most adverse conditions to which the specimens were exposed. All their samples had bursting and crushing strengths after exposure considerably higher than the requirements for AC pressure pipe. They were unable to incur high levels of degradation in their samples in the 13 year period. To speed up the process of AC pipe degradation in the laboratory, efforts have been made to use acids with low pH to accelerate the degradation process and model the process of deterioration that occurs in service. Accelerated cement leaching tests conducted under well controlled laboratory conditions show a decrease in residual strength with cement leaching (Carde & Francois 1997). This confirms the suspicion

that there is a correlated relation between the formation of soft AC and reduction of AC pipe residual strength. However, Davis et al. (2008) argue that the applicability of rate models generated with accelerated cement leaching tests to AC pipes in service is limited and further complicated by the inherent uncertainty in the environmental conditions that a buried AC water pipe is exposed to. While these models might be inherently flawed, the results they offer can be of significant value in understanding strength loss as a function of degradation. Accelerated acid degradation provides strength values at high degradation levels that would otherwise not be attainable in certain environments. This testing allows for a closer study of AC pipe behavior at controlled levels of degradation, and plays an important role in identifying the shape of the AC pipe degradation versus time curve.

2.10 Rate of Degradation

The parameters controlling the rate of degradation and their effect on pipe performance are not fully understood (Mordak and Wheeler 1988). If the deterioration process simply removes the cement matrix from the pipe at a constant rate, then the rate of degradation would remain constant unless other factors change, such as a drop in groundwater level or a change in the chemical quality of the water. If conditions favor the deposition of replacement minerals (such as iron, zinc, and manganese), the by-products from pipe deterioration may eventually develop into a layer that impedes the movement of the reactants to and from the pipe surface, thereby slowing the deterioration process. This layer may eventually become sufficiently thick that the degradation process cannot continue (Hu et al. 2013). For example, a color change to red on the pipe surface is an indication of iron deposition and may affect pipe condition by slowing or even stopping lime leaching. The conditions and amount of precipitation of such protective coatings depend on the concentration of the metal and silica ions and the pH and redox condition

of the water (Millette et al. 1984). Also, some elements, such as zinc, iron and manganese, can provide protection in the form of oxide coatings on the surface in under-saturated conditions (with respect to calcium carbonate). However, if the replacement minerals occupy a greater volume than the original material, the expansion pressure may crack the AC material, enabling corrosive water to penetrate deeper into the unaltered pipe wall, as commonly occurs in conventional concrete structures (Hu et al. 2013). While it is difficult to give an accurate representation of the rate of degradation, utilities concerned with AC pipe failure need a clearer understanding of the remaining service life of the water mains. The rate at which AC pipe wall thickness degrades is highly variable and affected by several factors, therefore it is generally assumed that an unequivocal determination of the trajectory of AC pipe deterioration is not possible (Hu et al. 2013).

Research conducted by Stark and Charlton (2008) shows that the leached material remaining on and near the surface tends to act as a barrier through which moisture must diffuse in order to continue the leaching process. However, the state of practice is to conservatively predict the remaining service life by assuming a linear rate of degradation (Kettler and Goulter 1985; Hu et al. 2013; Davis et al. 2005). The rate of degradation is determined by the ingress rate of lime leaching chemicals or sulfates into the cementitious matrix, which is governed by the permeability of this calcium silica hydrate (C-S-H) matrix. The associated damages are dependent on the strength of the acids, and on the solubility of the minerals in the hydrated cement matrix (Zivica and Bajza 2001).

As lime leaching and sulfate attack all require an environment with soil pore water present for ions to move through the soil, an arid environment with low soil moisture content will minimize leaching and sulfate attack. When the leached products cannot be dispersed into

the surrounding soils, they will become highly concentrated and slow down further leaching (Chowdhury et al. 2012).

2.11 Results from Specific Literature

While there is a plethora of data available in the literature, results from a few notable papers have been included for comparison.

Hu et al. (2013)

The authors conducted a survey of breakage rates from 20 utilities across the US and Canada to correlate breakage rates with AC pipe characteristics (like pipe size) and working environments (water quality, water temperature, burial depth, backfill soil types, and soil pore water pH and sulfate content). Further samples were collected from 10 different utilities for inspection and condition assessment. Techniques employed include chemical (phenolphthalein staining test), and mechanical (Shore D hardness test, crush test, and pressure test). In addition, scanning electron microscopic analysis was performed on select samples to further understand the nature and extent of deterioration. The level of degradation measured on both internal and external surfaces varied significantly from sample to sample. While, the internal degradation was uniform throughout the sample, the external degradation showed high level of variance across the cross-section of the sample. Phenolphthalein staining correlated moderately well with data from scanning electron microscopy. The authors suggest the use of Phenolphthalein as a preferred method of measuring degradation, since it's relatively cheaper, simpler to do, and more testing services are available for the work in North America. The hardness across the cross-section of pipes from the different utilities showed considerable difference. Hardness in the mid-section was found to be higher than the inner surface, but lower than the outer surface. The authors state that the reason for the real or apparent hardness on the outer surface is not clear,

and that there may be a brittleness effect, even though there is degradation and some loss of strength. Both inner and outer hardness tends to decrease with an increase in degradation; however, there is high scatter in the data.

Samples tested showed that all but the weakest pipes were still capable of bearing the design external load due to overburden. A high coefficient of determination (0.91) was obtained when comparing residual rupture modulus calculated from the crushing load versus degradation plot shown in Figure 2-3, indicating a highly correlated relationship between the two parameters. The authors continue by noting that the increase seen in residual rupture modulus with a decrease in undegraded wall thickness is due to the fact that the degraded portion of an AC pipe still contributes, to a certain degree, to the strength of the pipe. They state that this is the reason pipes with complete degradation of their pipe wall thickness indicated by phenolphthalein are still capable of bearing loads.

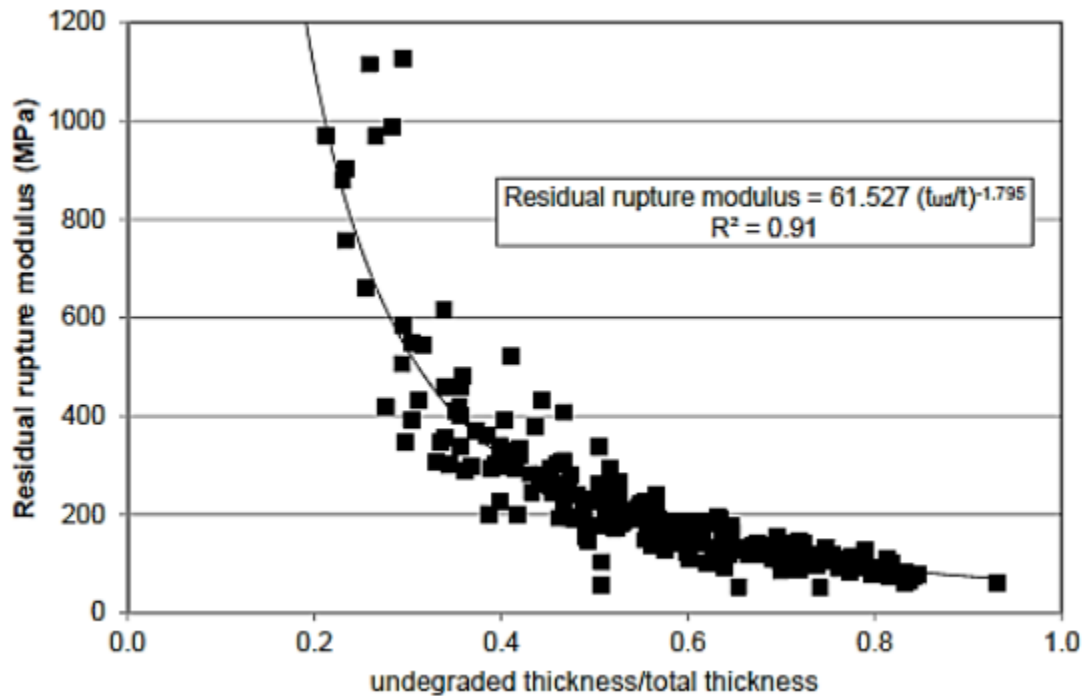

Figure 2-3. Correlation between crushing test and level of degradation from Hu et al.,

For select samples where hydrostatic tests were performed, results showed that there were samples with lower hydrostatic strength than design values. However, all samples even the lowest measured failure pressure was still capable of bearing the working (operating) internal pressure. There was fairly good coefficient of determination (0.59) while comparing residual tensile strength, which is calculated from the hydrostatic data, with phenolphthalein degradation. This suggests that although level of degradation is a major factor for determining bursting pressure, there are other unknown factors affecting the hydrostatic strength of AC pipes.

Chowdhury et al. (2012)

The researchers collected a total of 155 AC pipe samples and related data provided by the three utilities participating in this study. Most samples were collected during water main break repair work and some were obtained from water main replacement projects. The samples had a length of about 400 mm, but some were smaller pieces. Visual inspection, physical (hardness, crush, pressure, and bending tests), chemical (phenolphthalein), and elemental analysis using scanning electron microscopy with energy dispersive spectroscopy test were conducted whenever possible. The authors estimated degradation depths from elemental analysis and appeared to be in similar range as those from the phenolphthalein tests. Both internal and external pipe degradation values varied significantly depending on the operating condition, and the soil environment, which is influenced by both soil and climatic conditions. In general, variation in degradation rates were much greater on the outside of the pipe compared to the inside of the pipe. Phenolphthalein tests are more likely to be used in an ongoing condition assessment program by a utility due to the high cost of elemental analysis. Similarly to the Hu et al., 2013 findings, the hardness in the middle section was higher than that on the inner surface, while the hardness on the outer surface were generally higher than those in the middle section.

The authors suggest this may be related to the waffle pattern on the outside surface of AC pipes, which made it difficult for the durometer to be positioned in close contact with the outside surface. Hu et al., 2013 suggested the outer surface might be undergoing hardening through chemical reactions with the soil. While there were no correlations with other tests performed by Chowdhury et al. (2012), there was a reduction of strength with increased degradation in tested samples. Deterioration resulted in about 18% of pipe samples with transverse (crushing) strength below specifications. The authors considered the rate of degradation to be linear and did not perform separate rate tests. Degradation rates were calculated by dividing the measured degradation depth of a pipe sample by the service years, essentially assuming a linear rate. In general, variation in degradation rates was much greater on the outside than on the inside. This may be because the soils surrounding AC pipes vary significantly for a given utility, but all AC pipes in a utility likely experience the same (possibly time varying) conveyed water quality. For this reason, a simple linear rate was assumed for the rate of degradation.

Harris, N., and Radlinski, M. (2012)

The authors conducted AC pipe condition assessment on the Alameda County Water District distribution system. The district serves 320,000 residential customers and contains 622 miles of AC pipe in its system. Forty seven pipe samples were removed and tested to assess this water distribution system. Laboratory testing consisted of microstructural examination using scanning electron microscope, assessment of chemical composition by energy dispersive spectroscopy, qualitative determination of pH level profile by phenolphthalein staining, hydrostatic pressure testing, crush strength testing, and petrographic analysis. Degradation was reported on both the inner and outer portions of the tested pipes. Significant variation was observed in the degradation depth between samples; stain varied from 0 to 0.30 inches on the

inner surface and 0 to 0.26 inches on the outer surface. The authors suggest this could be an indication that asbestos cement degradation is highly variable and dependent on several factors which could be both internal and external. Petrographic examination of the pipe cross-sections showed that measurable strength loss lagged well behind the leach front. This suggests that the hardness differs with a gradually changing gradient instead of a sharp drop when moving from a phenolphthalein stained surface (non-degraded) to a non-stained surface (degraded). Therefore, it is erroneous to classify degraded portions of AC as having no contribution to the strength of AC pipe.

For the measured crushing strengths there was high variation seen in the tested samples. The values were found to range from 6,400 to 13,000 psi, which is above the minimum crushing strength for new 6 and 8 inch pipe (AWWA standard is 6,400 psi which corresponds to approximately 5,500 lbs/foot ultimate crushing load for class 150 8 inch pipes). Decreasing pipe crushing strength with increasing Phenolphthalein unstained thickness was seen but with weak coefficient of determination (0.29). Pipe samples withstood a pressure of four times the rated working pressure for the class of pipe, without failure. This suggests that even pipes experiencing significant levels of degradation are capable of providing hydrostatic resistance. The pressure was increased to determine the maximum hydrostatic pressure that the tested pipes could withstand. Four pipes failed between 675 and 730 psi and the remaining pipes endured 625 to 760 psi prior to failure of the rubber gaskets sealing the pipe ends. Due to weak data correlation from strength testing, the service life predicting model was developed on leak event history. This methodology was based on an assumption that as pipe degrades the frequency of pipe failures increases. Based on analysis of the leak data, the primary factors positively identified as influencing the leak rates in the system were pipe age and pipe nominal size. Lack

of reasonably strong correlations precluded a possibility of incorporating soil characteristics, climate, and groundwater into the model. The leak rate was assumed to be a linear function of pipe age and a non-linear function of pipe diameter. Therefore, as pipe age increased the leak rate increased linearly. The larger diameter pipes were less susceptible to leaking, and the reason for this is unclear. The increased thickness and surface area is assumed to affect this correlation.

Stark and Charlton (2008)

Stark and Charlton, 2008 researched the condition of AC pipes in the Deep Bay Waterworks District on Vancouver Island in their report. The researchers conducted visual examination aided by low power stereomicroscopy; crush strength testing; hydrostatic strength testing; hardness and scratch testing; phenolphthalein indicator “staining”; and chemical analysis of pipe cross-sections using scanning electron microscopy/x-ray energy dispersive spectography (SEM/EDS) techniques. Stark and Charlton reported degradation on both internal and external pipe surfaces. Therefore, the Deep Bay Waterworks District on Vancouver Island consists of aggressive conveyed water and aggressive soil. Stark and Charlton used the hardness results to compare with phenolphthalein. Softening was detected on both the inside and outside pipe surfaces of two samples, correlating with the phenolphthalein results showing both internal and external degradation. For this reason, they suggest that the phenolphthalein staining test is performing well in estimating level of degradation. Similarly to the Harris and Radlinski (2012) findings, the class 150 AC sample met the crush strength requirement for new pipes. In fact, the tested samples also met the requirements for class 200 by failing at 8,800 lb/ft. The authors noted that the pipes tested had hydrostatic failure which exhibited a longitudinal fracture with one forked end. The report only presented one failure pressure value which was 735 psi. Samples from Vancouver Island showed that the cement mortar leaching of AC pipe appears to occur due

to an inward movement of a distinct front separating the leached material from the sound pipe body. The leached material remaining on and near the surface tends to act as a barrier through which moisture must diffuse in order to continue the leaching process. As the thickness of this barrier increases (i.e. as more of the pipe wall is leached), the rate of leaching slows. Therefore, the authors suggest that the leaching rate is not linear.

Slaats et al. (2004)

The authors conducted their research to address the over 40,000 km of AC pipe in the Netherlands. The number of fractures on these pipes had spiked in the years leading up to the time of research. Phenolphthalein test and Georadar test methods were used to assess the condition of the water system. Degradation measured on the internal surface showed considerable relationship between the aggressiveness of conveyed water and the leaching of the inside of AC pipes. However, the relationship between the leaching of the outside of AC pipes and the soil is less clear. The authors were able to better estimate the effect of aggressive conveyed water since, the data can be easily found and tends to remain constant across the utilities in the Netherlands. After analyzing the breakage data available from the Netherlands, Slaats et al. (2004) have identified specific factors that affect the leaching of AC pipe. Leaching rates from asbestos cement can primarily be observed to increase in cases where piping diameters are small (100 to 150 mm or 4 to 6 in), residence times are long, and the drinking water has a low saturation Index (SI) and a low buffer capacity.

Mordak and Wheeler (1988)

Concerns about asbestos leaching into the water mains in the UK led to the comprehensive study of the AC water mains by Mordak and Wheeler (1988). They identified 11% (37,500 kms) of the UK system to be asbestos cement, which serves 12.1 million people. In

addition to visual examination both physical (hardness, and crush) tests and chemical (elemental analysis, and phenolphthalein) tests were performed. Degradation measured using Phenolphthalein showed very good correlation with elemental analysis using scanning electron microscopy. Both scanning electron microscopy and Phenolphthalein showed varying levels of degradation from sample to sample and also across the cross-section of the external surface of the tested samples. Tested locations in the UK showed large differences between the maximum and minimum hardness readings on the pipe samples. For this reason, Mordak and Wheeler conclude that degradation, when present, is non-uniform. The authors also observed that the loaded pipes generally failed at the 12 and 6 o'clock positions first, followed immediately by cracking at the 3 and 9 o'clock positions. This is consistent with stress concentration points for a pipe geometry loaded in this manner. There is however, high scatter in the crushing data when plotted against degradation, thus either the initial strengths of the pipes vary considerably, or during service the pipes are weakened by a mechanism which is not revealed by the elemental or phenolphthalein tests as presented in Figure 2-4. (It is important to note that the Hu et al. (2013) data when plotted without consideration of residual rupture modulus exhibits similarly high scatter.)

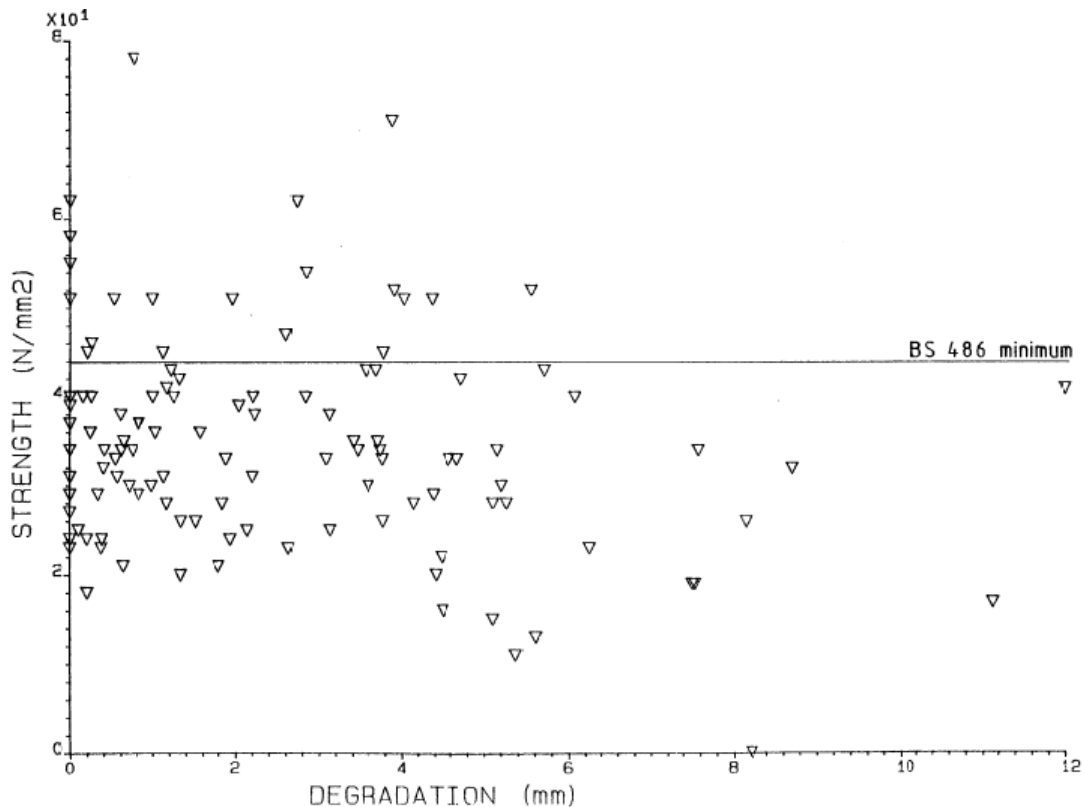

Figure 2-4. Crushing load vs Degradation from Mordak and Wheeler (1988)

Breakage data collected from UK suggests that failure rate increases linearly with age according to the following relationship:

$$F = 0.00697A + 0.122$$

Where F = failure rate (failures/km year) and A= age in years. There is limited evidence from America that the presence of iron and other metals in the water may result in reduced rates of attack. Other factors that affect the rate of degradation are the place of manufacture of the pipes, the cement used, the formulation of the bitumen coatings, the extent of damage incurred during installation, the abrasive characteristics of the water, particularly suspended solids which may remove any protective coating, and changes in treatment/water source during the life of the pipe. Pipe flow conditions which may cause removal of the fibers have not been studied and are most probably transient in nature, thus making any predictions unreliable.

Denison and Romanoff (1951)

Denison and Romanoff (1951) were especially interested in observing asbestos cement pipe degradation for samples buried in the soil for an extended period of time. In 1937, 10 samples of 6 inch diameter pipe were installed at each of 15 test sites with different soil properties. Two samples were removed after each of five periods of exposure. Therefore these 12 inch long samples were removed in 1939, 1941, 1946, 1948, and 1950. Laboratory examination was conducted to determine their hydrostatic bursting strengths, crushing strengths, water absorption and apparent specific gravity. Although there were no hardness tests performed by Denison and Romanoff (1951), the water absorption test performed shines light on the method of AC pipe softening. Absorption of water was not confined to the softened layer but progressed beneath the softened layers. However, this did not result in strength loss, indicating that the area beyond the softened layers where water has progressed is capable of providing strength. This finding is in correlation with Harris and Radlinski (2012), who found that the strength loss lagged behind the leached front. Following the 13 years of exposure from 1937-1950, the 4 and 6 inch pipes placed in aggressive soil had crushing strengths much higher than the manufacture requirements. No consistent trend toward progressive reduction in strength with duration of exposure is indicated. Hydrostatic test results showed strength values well above manufacture requirements. No definite correlation between strength and length of exposure was indicated by the data for the different soil environments. Maximum strength of AC pipe was not attained until several years of exposure. This suggests that the first few years of AC pipe exposure result in increased strength, also considered a curing phase. However after the curing phase, there was some noticeable decrease in strength as age of pipe progressed. The 13 year exposure did not result in sufficient degradation to assess pipe performance beyond design pressures. By placing samples in different soil environments, the researchers were able to observe different changes in

AC pipe surface depending on the soil chemistry. Samples in alkaline soil environment resulted in hardened surfaces instead of softened AC. Therefore, the pipe was less permeable to leaching which leads to non-linear rate of leaching. Other soil chemistries didn't show considerable effects on the AC pipe surface while others resulted in softening of AC pipe.

2.12 Conclusion

While the methods of AC pipe degradation are well recorded, the rate of AC pipe degradation is not fully understood. AC pipe degrades both internally and externally through the progression of degrading elements from the surface inwards. There are various variables that affect the extent of AC pipe degradation, however there is still much work required to understand how these variables interact with AC pipe in service. There is sufficient research in the area of AC pipe condition evaluation and identification of AC pipe degrading elements. Both internal and external degradation can be accurately measured by using phenolphthalein staining. Previous work has shown that phenolphthalein is an appropriate method of measuring degradation by comparison with scanning electron microscopy and hardness tests. Residual strength can also be measured using crushing and hydrostatic testing. ASTM C500 (2011) details the procedures to conducting these destructive tests. The correlation between degradation and residual AC pipe strength is not clearly defined in the literature. Various researchers have found high scatter in the data and have sorted to using other methods such as leakage monitoring to predict future pipe performance. Others have accelerated the degradation process by using strong acids which provides valuable information to understand the rate of AC degradation.

3 Asbestos Cement Pipe Evaluation

3.1 Introduction

The Bella Vista Village Property Owner's Association (BVVPOA) municipal water distribution system consists of cast iron, poly (vinyl chloride) (PVC), galvanized iron and approximately 300 miles of AC pipe. This water distribution system as shown in Figure 3-1, has AC pipe that makes up a significant percentage of the water system. The AC pipe in the distribution system ranges from 6-14 inches in diameter.

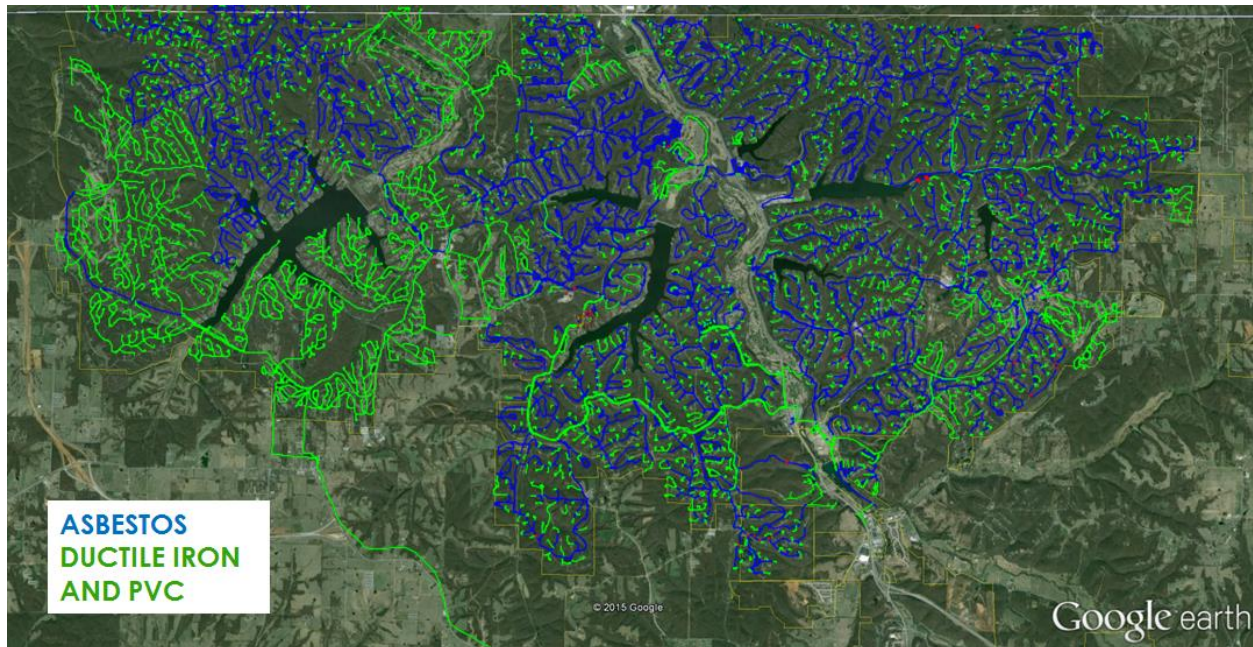

Figure 3-1. Map of BVVPOA showing AC water mains

The various deterioration mechanisms and environmental parameters that affect AC pipe have been highlighted in Section 2.3 AC Pipe Degradation. These factors include lime leaching due to aggressive water, sulfate attack, and low pH aggressive soil. The focus, of this chapter, is on establishing the current level of degradation in the system and creating a method for estimating remaining service life.

3.2 Sample Collection

The BVVPOA utility conducted all sampling of AC pipes for this study. Locations were initially randomly selected at the utility’s discretion. Since there were no prior studies conducted on the condition of the AC pipes, there was no way of identifying specific sampling locations of concern. Most of these samples were collected during repair work conducted by the utility. However, BVVPOA provided a representative distribution of samples across their water distribution system. Sampling locations for the project are presented in Figure 3-2. After a period of random sampling, specific locations were highlighted to provide samples in locations missed during the random sampling period. These locations were selected either since there were not enough representative samples in that area, or samples from the location had exhibited concerning levels of degradation and further sampling was required to better quantify the degradation in the area.

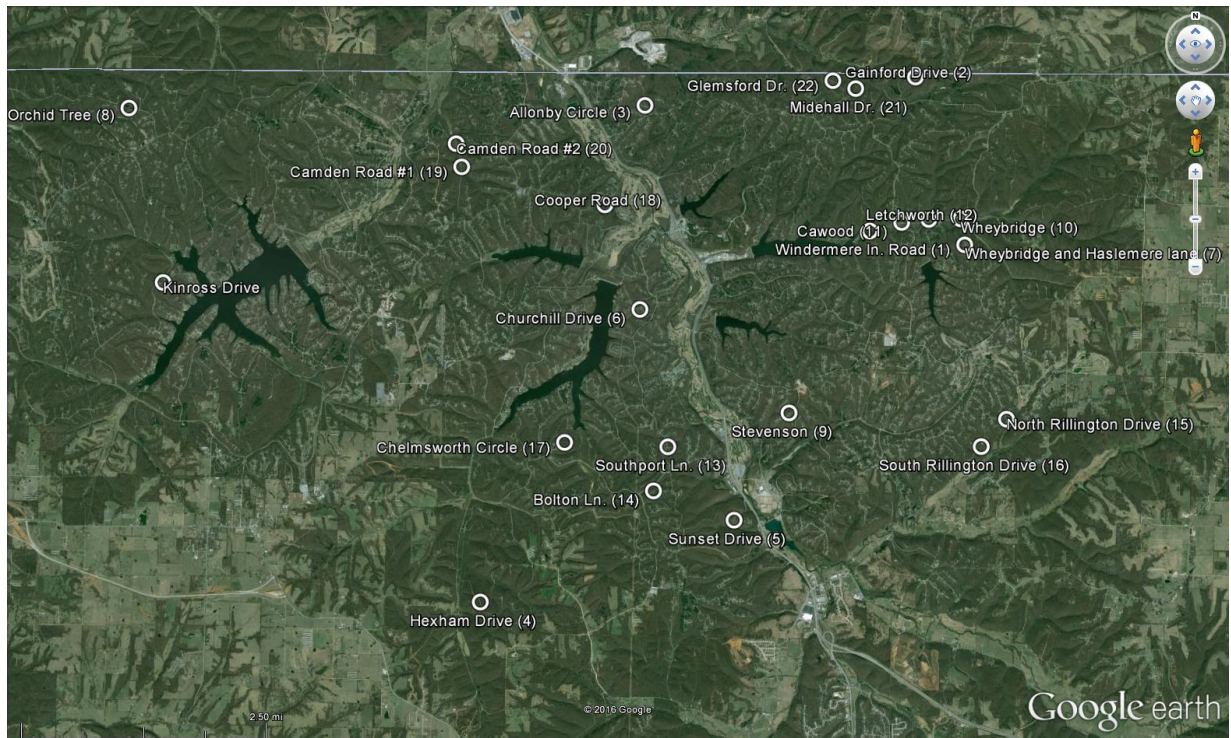

Figure 3-2. Sampling locations from Bella Vista

While there are no special licenses required to conduct AC pipe sampling, there are special trainings given to the technicians conducting the removal of these samples to ensure proper safety procedures. Although, AC pipes are considered non-friable, the sampling process presented in Figure 3-3 below can release asbestos fibers into the air.



Figure 3-3. AC pipe sampling procedure

Bella Vista Utility personnel excavated the soil around the pipe to be sampled, and cut the desired section from the water main. Prior to using a concrete saw, proper facemask must be used to prevent inhalation of asbestos fibers released during cutting (step 2 of Figure 3-3). The desired one foot and four foot sections are then measured and cut. The utility delivered these samples wrapped in plastic to the laboratory where condition assessment testing was conducted. Along with the AC pipe samples, data sheet containing pertinent information about the location of the pipe (GPS coordinates and street address), surface moisture, year of installation, pipe manufacturer, bedding condition, date sampled, working pressure, and reason for selection of

location were provided. Once the samples were received they were labeled accordingly and stored until testing.

BVVPOA provided 48 (one foot long) 6” nominal diameter, 24 (four foot long) 6” nominal diameter, 6 (one foot long) 8” nominal diameter, and 3 (four foot long) 8” nominal diameter AC pipe samples. Table 3-1 below summarizes the samples collected during the project and illustrates the relative age of the AC pipes in the BVVPOA water system.

Table 3-1. Summary of AC pipe samples collected for the project

Sample No.	Street Address	Longitude	Latitude	Pipe Class	Year installed	Type of Sample	Outside diameter (in)	Thickness (in)	Working Pressure (psi)	Surface Moisture	Manufacturer
1	Windermere Lane	-94.212379	36.475460	150	1973	1'	7.33	0.74	74	Dry	Johns-Manville
						1'	7.32	0.76			
						4'	7.33	0.73			
2	Gainford Drive	-94.203919	36.498321	150	1973	1'	7.15	0.69	85	Dry	Johns-Manville
						1'	7.12	0.68			
						4'	7.09	0.68			
3	Allonby Circle	-94.253792	36.494205	150	1973	1'	7.13	0.70		Wet	Johns-Manville
						1'	7.12	0.69			
						4'	7.17	0.71			
4	Hexham Drive	-94.283890	36.420692	150	1976	1'	7.15	0.68		Dry	Johns-Manville
						1'	7.13	0.70			
						4'	7.14	0.68			
5*	SunSet Drive	-94.237541	36.432667	150	-	1'	9.55	0.89		Dry	Johns-Manville
						1'	9.54	0.89			
						4'	9.55	0.90			
6	Churchill Drive	-94.254753	36.463799	150	1973	1'	7.18	0.71		Wet	Johns-Manville
						1'	7.22	0.72			
						4'	7.23	0.70			
7	Wheybridge and Haslemere Ln.	-94.195038	36.473347	150	1973	1'	7.17	0.72		Wet	Johns-Manville
						1'	7.12	0.69			
						4'	7.09	0.67			
8	Orchid Tree Lane	-94.348915	36.493690	150	1981	1'	7.18	0.71		Dry	Johns-Manville
						1'	7.16	0.70			
						4'	7.18	0.70			
9	Stevenson Lane	-94.227432	36.448475	150	1973	1'	7.18	0.68		Dry	Johns-Manville
						1'	7.34	0.73			
						4'	7.35	0.73			
10	Wheybridge Drive	-94.195679	36.477249	150	1973	1'	7.12	0.69		Dry	Johns-Manville
						1'	7.13	0.69			
						4'	7.12	0.69			
11	Cawood Drive	-94.206520	36.476719	150	1973	1'	7.18	0.71	110	Dry	Johns-Manville
						1'	7.19	0.71			
						4'	7.18	0.71			
12	Letchworth Drive	-94.201500	36.477173	150	1974	1'	7.19	0.72	140	Dry	Johns-Manville
						1'	7.21	0.72			
						4'	7.18	0.71			
13	Southport Lane	-94.249657	36.443485	150	1973	1'	7.21	0.72		Dry	Johns-Manville
						1'	7.25	0.74			
						4'	7.25	0.74			
14	Bolton Lane	-94.252289	36.436989	150	1974	1'	7.16	0.70		Wet	Johns-Manville
						1'	7.17	0.71			
						4'	7.11	0.68			
15*	North Rillington Drive	-94.187592	36.447536	150	1974	1'	9.48	0.89		Dry	Johns-Manville
						1'	9.44	0.88			
						4'	9.46	0.88			
16*	South Rillington Drive	-94.192268	36.443497	150	1974	1'	9.45	0.87		Dry	Johns-Manville
						1'	9.46	0.88			
						4'	9.45	0.88			
17	Chelmsworth Circle	-94.268570	36.444122	150	1974	1'	7.04	0.65		Dry	Johns-Manville
						1'	7.09	0.65			
						4'	7.09	0.65			
18**	Cooper Road	-94.261192	36.479351	150	1970	-	-	-	-	Dry	Johns-Manville
						-	-	-			
						-	-	-			
19	Camden Road #1	-94.287621	36.485039	150	1970	1'	7.24	0.73		Dry	Johns-Manville
						1'	7.20	0.72			
						4'	7.23	0.73			
20	Camden Road #2	-94.288666	36.488510	150	1970	1'	7.23	0.73	-	Dry	Johns-Manville
						1'	7.22	0.72			
						4'	7.19	0.71			
21	Midenhall Drive	-94.214935	36.496624	150	1973	1'	7.42	0.78		Dry	Johns-Manville
						1'	7.40	0.78			
						4'	7.37	0.77			
22	Glemsford Drive	-94.219131	36.497810	150	1973	1'	7.33	0.75	-	Dry	Johns-Manville
						1'	7.35	0.76			
						4'	7.38	0.77			
23	Kinross Drive	-94.342450	36.467771	150	1981	-	7.40	0.75		Dry	Johns-Manville
						-	-	-			
						-	-	-			

*Sampled pipe has a nominal 8" diameter

**Cooper Road Sample 18 is from a live tap coupon

3.3 Condition evaluation methods

Methods for evaluating AC pipes can be grouped into two distinct methods, namely: destructive and nondestructive. Destructive tests allow for residual strength measurements and do not permit further testing on a pipe sample. The residual strength can be physically measured using either hydrostatic testing or crushing testing. Non-destructive testing methods such as visual inspection, phenolphthalein staining and hardness testing can be used to assess the level of degradation of the pipe.

3.3.1 Non-Destructive Testing

The non-destructive testing employed in this research include visual examination of the pipe surface for obvious signs of damage, phenolphthalein staining for direct measurement of level of degradation, and measurement of hardness to classify soft and hard AC. Each of these tests provide unique, valuable information regarding the current condition of AC pipe.

3.3.1.1 Visual Inspection

Most of the samples delivered by BVVPOA were not degraded to the extent that their condition can be evaluated visually. However, some samples have notable physical defects caused either through installation or excavation for sampling. Pictures are taken of all pipes to keep a digital catalogue after they have been washed and cleaned to remove soil. Any obvious anomalies are recorded and the samples are marked for testing. Common reddish discoloration from iron deposit is noted with special care, since it could affect the rate of AC pipe degradation. This information is added to the data sheet, provided by the utility that also notes any discrepancies noticed by the crew while sampling.

3.3.1.2 Phenolphthalein staining

Phenolphthalein solution was applied to all pipe samples provided by BVVPOA. Phenolphthalein staining has been shown to be a reliable method to measure the level of degradation in AC pipes. The literature shows that there is good correlation between degradation results from Phenolphthalein staining and the much more advanced scanning electron microscopy (Mordak and Wheeler 1988). Areas which have experienced degradation due to either aggressive water or acidic external environment do not react with the phenolphthalein solution leaving the grayish AC pipe color remaining. AC pipe degradation doesn't result in reduction of pipe wall thickness. However, soft AC is formed at the degraded locations, causing a reduction in structural integrity. Below is the step by step process taken when performing phenolphthalein staining on AC pipe

Step 1. Exposing fresh surface

The pipe samples delivered need to be thoroughly cleaned for visual inspection prior to any testing. Once the pipe has been examined visually for any obvious cracks or irregularities, it can be prepared for phenolphthalein staining. The AC pipe surface has to be ground in order to expose a fresh surface that can allow reaction with the phenolphthalein solution to take place. This can be accomplished by either, using an angle grinder and carefully grinding the entire surface of the pipe, or by cutting through the pipe to expose the desired fresh surface. The grinding process also helps provide a flat surface for measurements to be taken as shown in Figure 3-4. Figure 3-4 also highlights the extent of irregularities across the pipe cross-section created from the sampling process. The amount of grinding is limited by the need to keep the samples at the appropriate lengths of one foot or four foot for crushing and hydrostatic testing.

Step 2. Application of Phenolphthalein solution

The phenolphthalein solution is applied to the freshly exposed surface of AC pipe. A sponge brush is soaked in the solution and brushed over the surface. The reaction occurs instantaneously and the discoloration is visible with the naked eye. The level of degradation can be measured by measuring the distance from the outer or inner surface up to the point of discoloration.



Figure 3-4. a) Surface before grinding; b) Measuring the pipe thickness after grinding

Step 3. Measuring level of degradation

The challenge in using phenolphthalein to measure degradation is coming up with a repeatable way of performing this test. AC pipe has inherently variable composition across its cross-section, therefore the level of degradation will be different across the entire surface. Soil pH is highly variable within small distances and could significantly affect level of external degradation across an AC pipe. To reduce the impact of this variability, degradation is measured

using a digital caliper at eight equally spaced locations across the surface of the pipe. The average of these eight measurements is then assumed to represent the level of degradation on that surface. It should be noted that Mordak and Wheeler (1988) used a similar method to manually measure degradation and were able to successfully correlate their results with the scanning electron microscopy test. Since each section of pipe tested has two surfaces, the average level of degradation from both surfaces is taken as the level of degradation of that pipe sample.

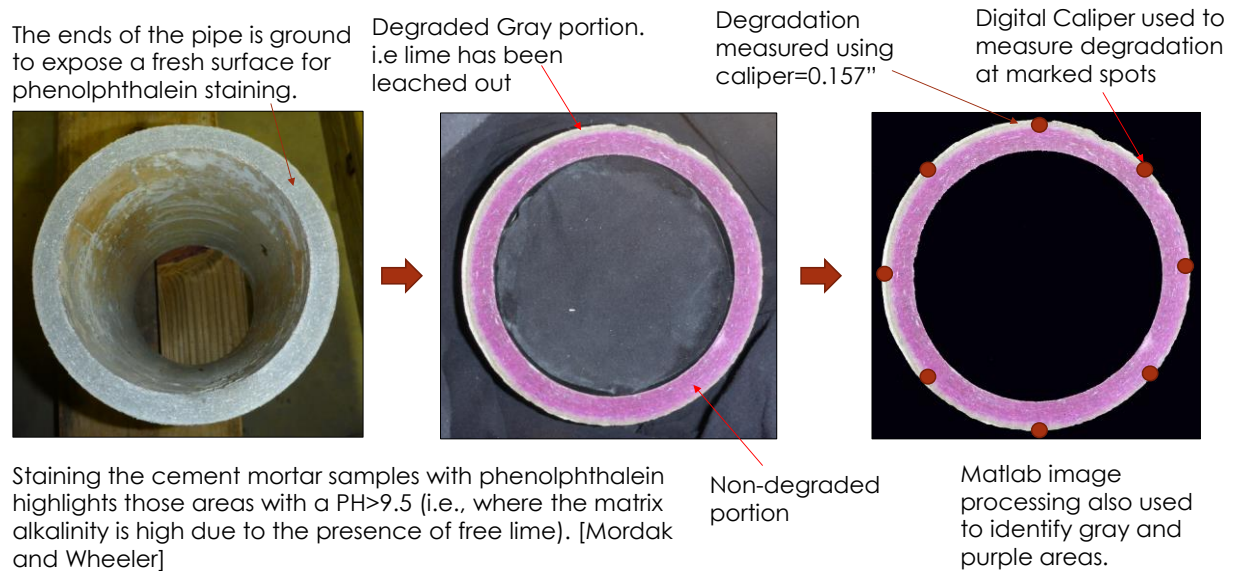
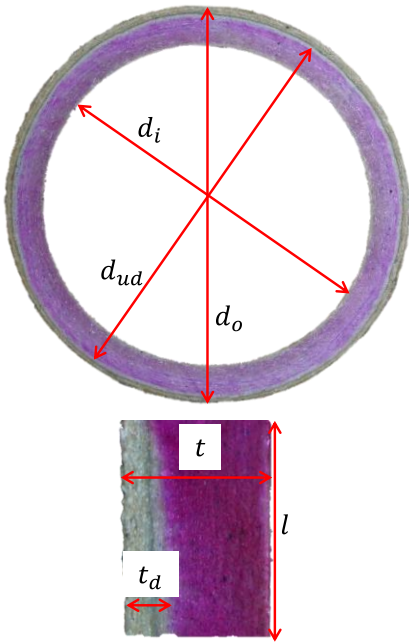

Figure 3-5. Phenolphthalein staining of AC pipe surface

To further reduce the inconsistency introduced by averaging the values of degradation, image processing software was employed. A Matlab code was utilized that can analyze a picture of the surface, and calculate the percent degradation as number of gray pixels divided by number of total pixels.

Although this method is a more repeatable form of degradation measurement, it has some drawbacks. The software has trouble identifying gray and purple pixels in the transition area between degraded and un-degraded. While this is not significant in some samples, there are certain samples where the light purple areas were counted as gray resulting in erroneous degradation levels. For this reason, results from the Matlab code were only used for comparison

with manually measured degradation. The percent degradation was calculated by separately calculating the area of the degraded portion and the whole cross-section. One of the two methods given below was used to calculate the area. Equation A was used for pipe samples to acquire initial degradation levels. Equation B was used to acquire degradation levels for rectangular faces of acid testing coupons.



$$A = \frac{\pi}{4} (d_o^2 - d_i^2)$$

$$A_{ud} = \frac{\pi}{4} (d_{ud}^2 - d_i^2)$$

$$\text{Percent degradation} = \frac{A - A_{ud}}{A} * 100\% \quad \text{Equation A}$$

Where A is the area of the pipe, A_{ud} is the undegraded area, d_o is the outside diameter, d_i is the inside diameter, and d_{ud} is the undegraded diameter.

$$A = t * l$$

$$A_d = t_d * l$$

$$\text{Percent degradation} = \frac{A_d}{A} * 100\% \quad \text{Equation B}$$

Where A is the area of the cross-section, A_d is the degraded area, t is the thickness of the coupon, t_d is the degraded thickness, and l is the length of the coupon.

3.3.1.3 Hardness Test

While the Phenolphthalein test gives an understanding of the level of degradation based on lime leaching, it is important to correlate this process with a loss of strength. The hardness test performed by using the Shore D Durometer shines a light on the extent of soft AC formation. This test gives an empirical number from 0-100; the higher the number, the harder the material. This number is only empirical and is not relatable with strength modulus. However, it serves an important purpose for comparing different surfaces. When AC pipe degradation occurs, there is soft AC formation, which results in the asbestos fibers not being as tightly packed. By pushing

the point of the durometer through the surface of the AC pipe, as illustrated in Figure 3-6, we can get a value that represents the hardness at that point on the surface of the pipe. The hardness is measured at eight non-linear spots (to avoid interference) across the surface of the AC pipe from inside to outside. This test provides an important correlation between lime leaching measured by phenolphthalein and loss of pipe structural integrity. Harris and Radlinski (2012) showed that leaching of calcium at the 90 percent level or change in pH does not necessarily equate with a significant loss of material strength. Therefore, the degradation front where soft AC is formed lags behind that measured from Phenolphthalein.

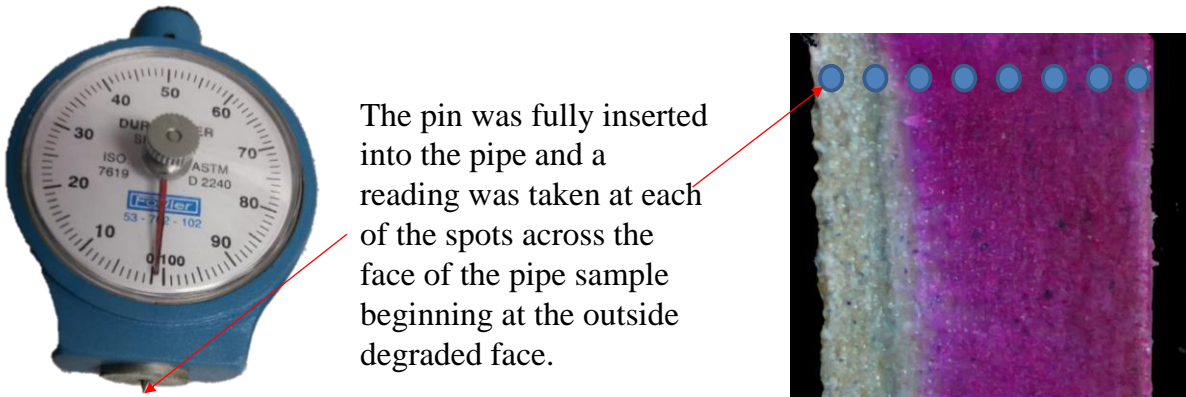

Figure 3-6. Measurement of Hardness using the Shore D Durometer device

3.3.2 Destructive Testing:

Destructive testing includes all testing where the sample cannot be reused. For this research the destructive testing methods include, crushing test for residual crushing strength measurement, and hydrostatic test for residual tensile (pressure) strength measurement.

3.3.2.1 Crushing Test

The testing methods employed so far provide an understanding of the level of degradation experienced by the AC pipe. The crushing test is able to provide residual strength of

AC pipes at different levels of degradation. Once the one foot samples have been cleaned, and the phenolphthalein test has been conducted, the crushing test can be performed.

ASTM C500 suggests a V-shaped three edge bearing method be used to perform the crushing strength. The lower press-block consists of a V-shaped support that has an included angle of 2.6 rad (150°) and is made of metal. The orientation is attached as shown from ASTM C500 (2011) in Figure 3-7 below. Interpose strips of rubber of thickness 0.7 inches are attached to the metal block. The flat upper press-block, made of the same material as the lower press-block has a width of 6 inches and length of 12 inches. The blocks are then attached to an MTS machine with a 20,000 pound capacity.

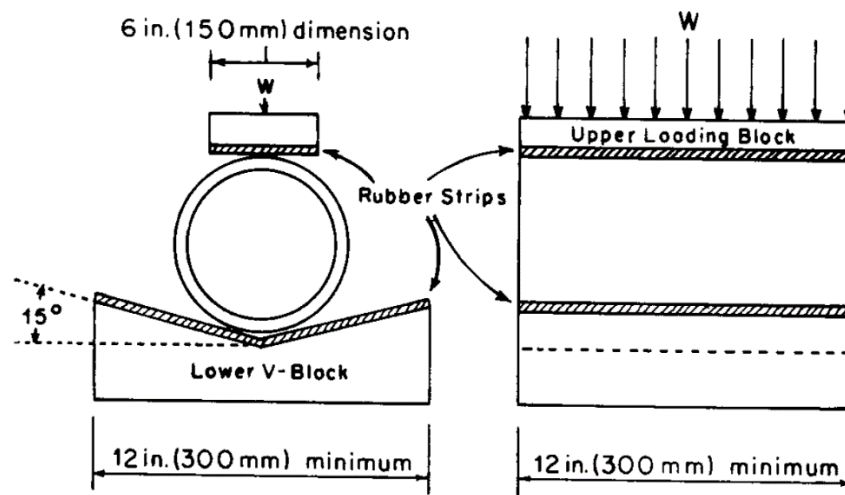

Figure 3-7. Crushing test configuration per ASTM C500 (2011)

The test is progressed at a rate of 0.05 in/min. Once breakage has occurred and the peak load drops, the test is stopped and the pipe can be removed from the MTS machine. The load path (Figure 3-8) must be studied, since load spikes might result in erroneous crushing load selection. The loaded pipes generally failed at the 12 and 6 o'clock positions first, followed almost immediately by cracking at the 3 and 9 o'clock positions as recorded by Mordak and Wheeler, 1988 and presented in Figure 3-9. Visual inspection of the crushed pipe is performed

and any unusual break patterns are recorded. The MTS machine records the test data in an excel file that can be accessed and analyzed for determination of peak load. The load path is also studied for any unusual drops or spikes in load while the test is progressing that could affect the final result.

The repeatability of the crushing test was tested prior to crushing all samples. Two samples from three sampling locations each were crushed and the failure load was compared and is presented in Figure 3-10. This test shows that there was only a maximum difference of 365 lb/ft, which is about a 4% difference, for samples from the same location. Therefore an error margin of about 400 lb/ft is assumed when comparing crushing loads from samples of different locations.

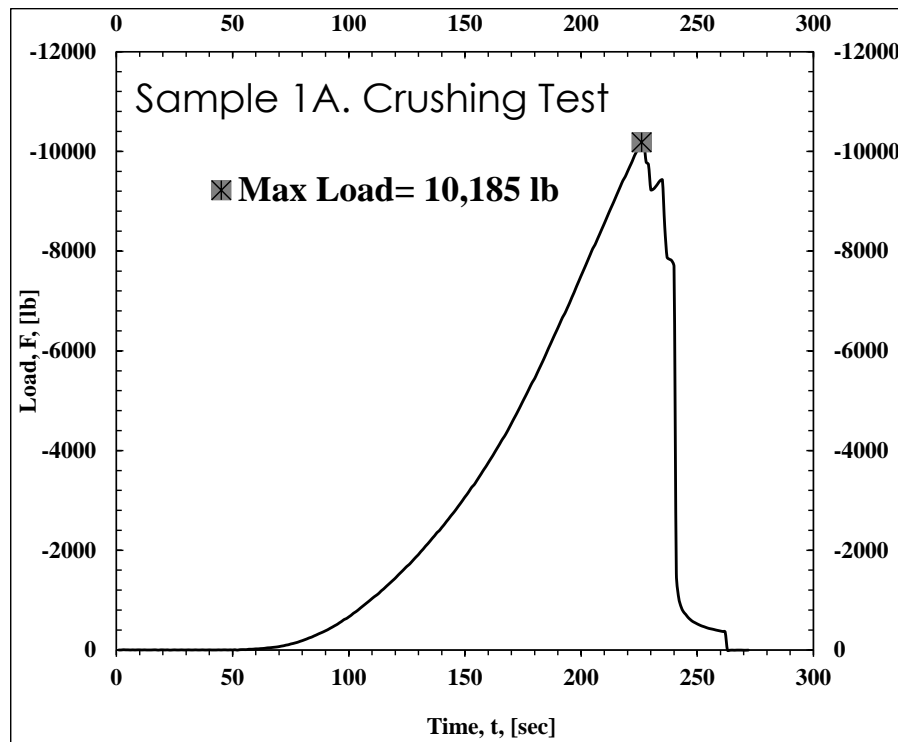
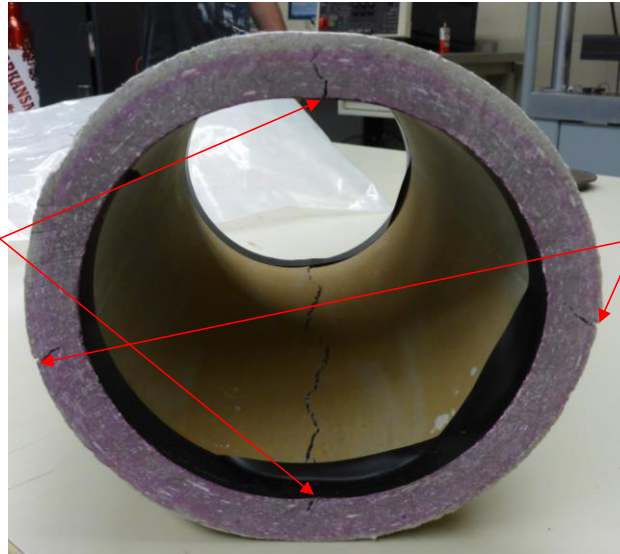

Figure 3-8. Picking failure load on sample crushing test data

Crack begins on the inside face at the top and bottom where the pipe is in tension



Crack begins on the outside face at the left and right where the pipe is in tension

Figure 3-9. Crushed sample with cracks highlighted

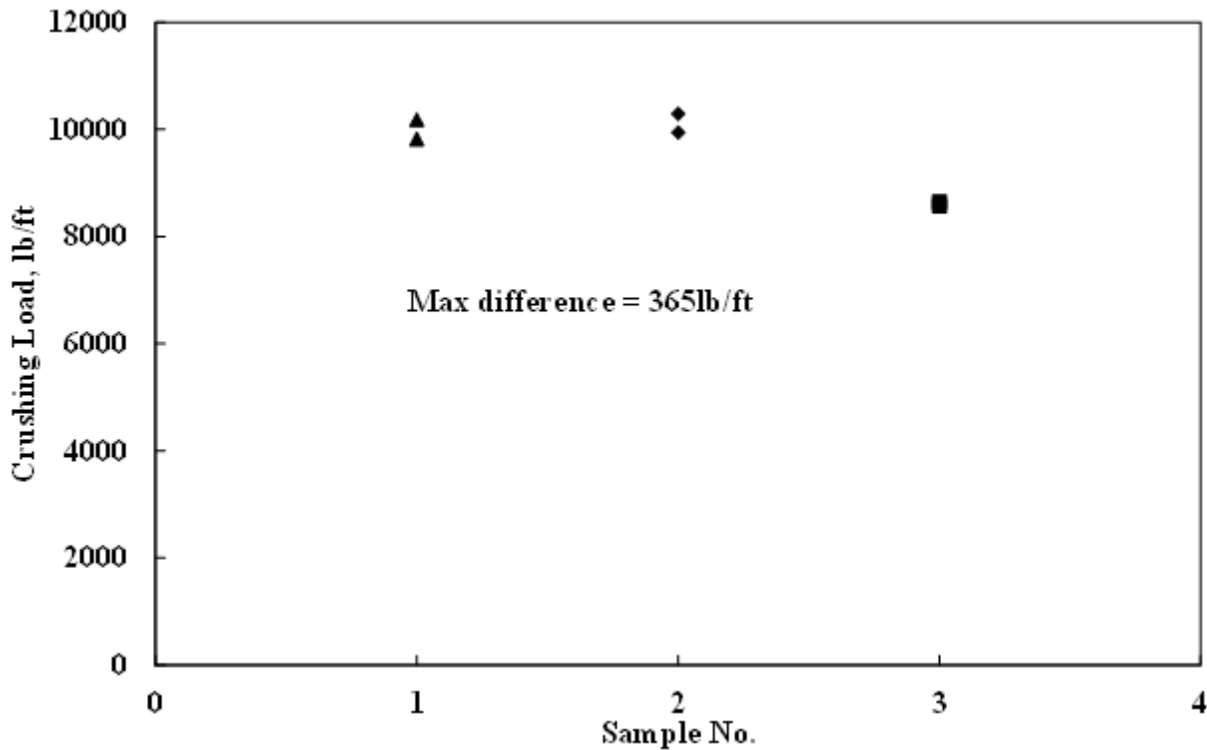

Figure 3-10. Crushing Test repeated for samples from same location

3.3.2.2 Hydrostatic Testing

The second type of destructive testing used to measure residual strength of AC pipes is hydrostatic testing. This test measures the amount of peak pressure the AC pipe can sustain

before failure. Once the four foot pipes have undergone phenolphthalein testing and the level of degradation has been recorded, the pipes are ready for hydrostatic testing. The ends of the pipe are carefully fitted with end caps using the following procedure, also shown in Figure 3-11:

1. Measure the outside diameter of the pipe and place the appropriate pusher plate on the pipe.
2. Apply rubber lubricant on the rubber seal that appropriately fits the pipe and place on the pipe. This should require some exertion of force such that once the rubber seal is on the pipe, it is not be able to move around easily.
3. Place pusher plate on pipe
4. Place top plate along with the rubber seal and hold in place using temporarily screwed threads.
5. Repeat the same process for the opposite end of the pipe. Once the pipe is fitted with the end caps, connect the two end caps using steel rods with threads machined on them.
6. Once the end gaskets have been tightened and securely placed on the pipe, the next step is to fill the pipe with water.
7. The gasket on the end cap is then sealed and the pipe full of water is ready for the hydrostatic testing.
8. The end cap is attached to a hand pump which has a dial gage for visual observation of pressure build up and is also fitted with a pressure transducer that records this data electronically.
9. The pipe is covered with a transparent plastic covering to prevent injury from any debris that may break off during breakage. [The pipe bursts at levels of pressure that can cause serious injury].

10. Per ASTM C500 requirements the water pressure is applied at a uniform rate of not less than 100 psi/s nor more than 1500 psi/s.

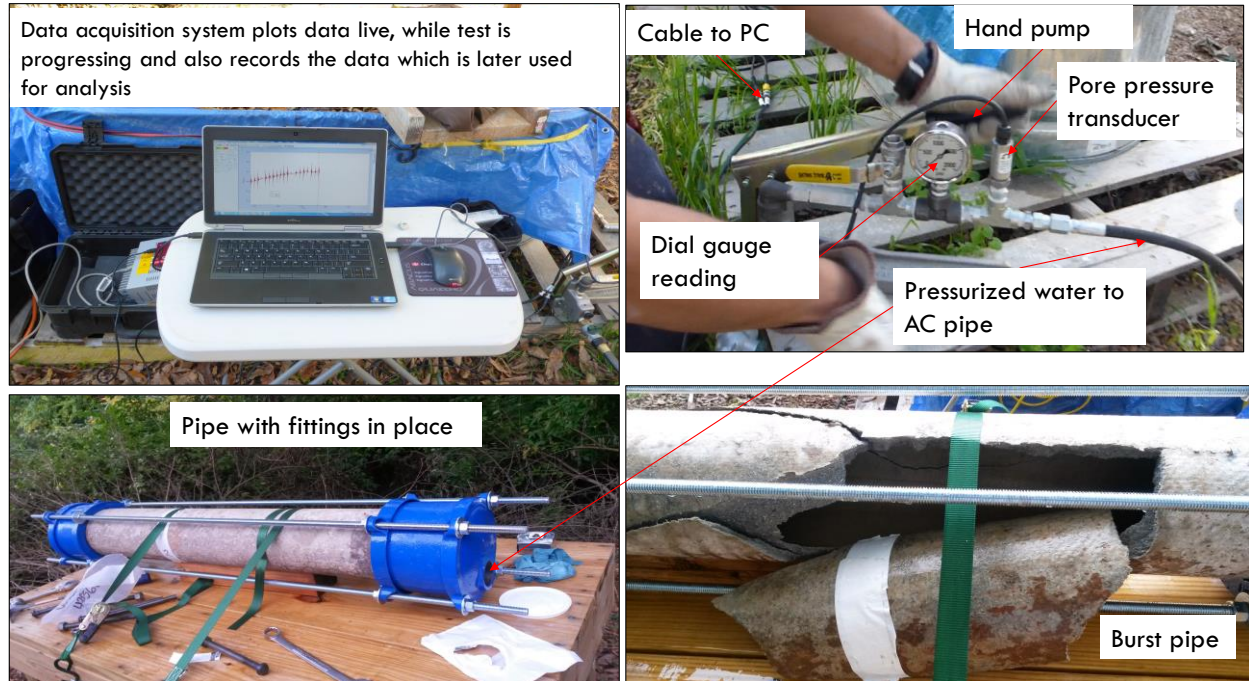

Figure 3-11. Hydrostatic test set up

Pressure is gradually built up until the pipe fails. The analyzed data from the pore pressure transducer provides an understanding of the load path as well as the final bursting pressure which is the main interest of this test. The plot shown in Figure 3-12 is from a sample that burst at 861.72 psi. The pressure build up can be seen to occur at a steady rate until the pipe can no longer sustain the level of internal pressure and bursting occurs. The spikes in the load path are considered to be dynamic pressure and not included in the peak pressure calculations. The dark solid line which represents the static pressure, is followed up to the failure point and recorded.

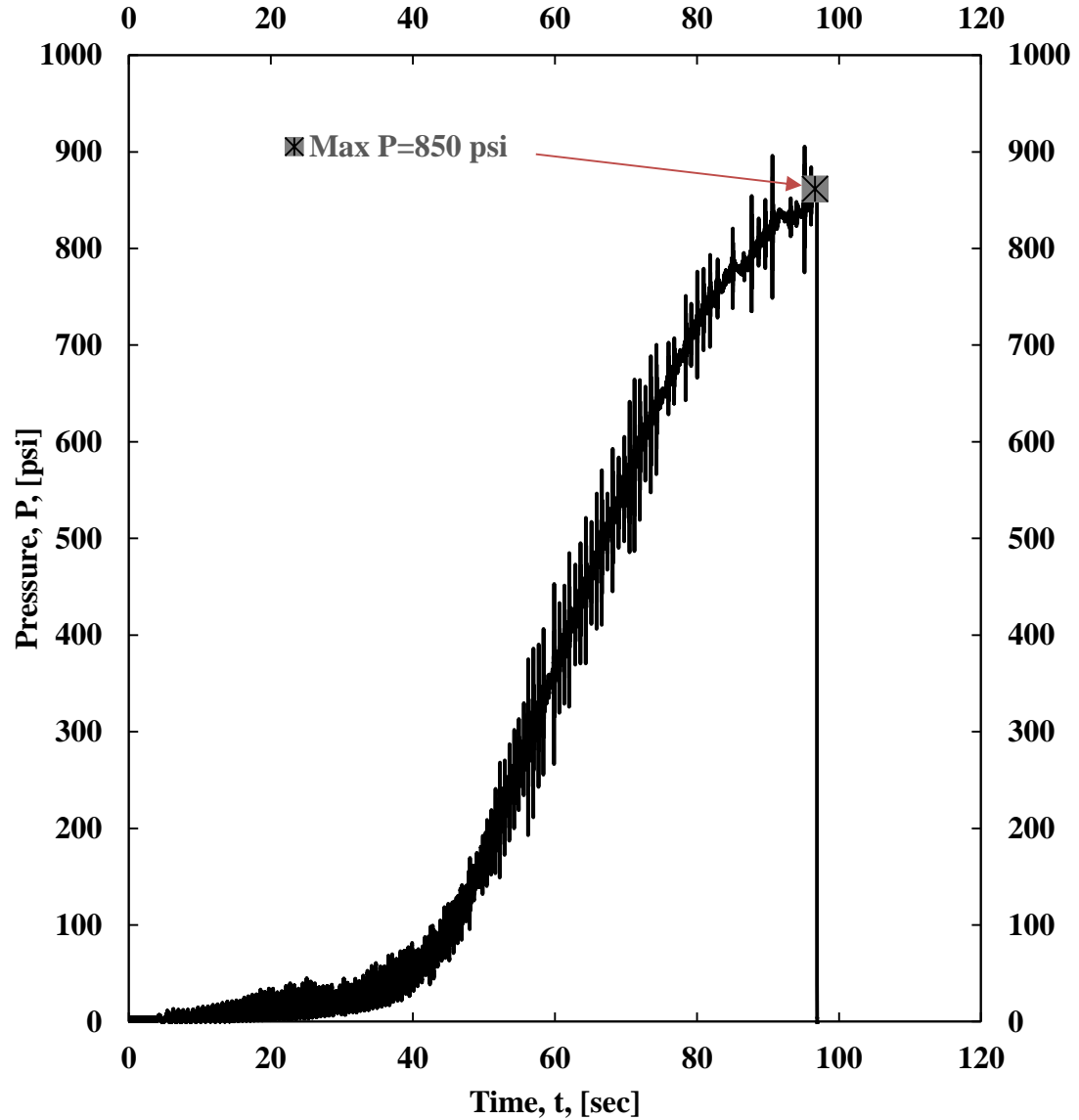

Figure 3-12. Hydrostatic test load build up and failure point

3.4 Conclusion

BVVPOA were able to sample from a representative distribution of location across their AC water system which allows for a generalized study on the entire utility's AC pipe condition. Both non-destructive and destructive testing was conducted on pipes from every sampled location. The testing was conducted following similar procedures to allow for data comparison.

The methods allow for a comprehensive understanding of the current extent of degradation and residual strength in the tested AC pipes.

4 Accelerated Acid Degradation of AC Pipe

4.1 Introduction

The importance of understanding the level of degradation in the water systems for utilities like BVVPOA is clear. It is also of equal importance to have the ability to predict the future performance of these AC pipes. The tests performed on the AC pipes so far allow for a clear understanding of the residual strength, and level of degradation. However, to better quantify the threshold values for AC pipes, and the rate of degradation, further testing is required. Placing AC pipes underground and observing the degradation until full degradation is achieved under natural conditions, would require a long period of time, possibly 100 years or more (Denison and Romanoff 1951). Efforts have been made to accelerate this process of degradation. Mordak and Wheeler (1988) used 20% nitric solution to further degrade their AC samples with relative success. For this reason nitric acid with different strengths were considered for the accelerated acid testing. Considering the variability in AC pipe composition and the irregular soil conditions that exist in-situ, any prediction in regards to remaining service life is bound to have considerable margin of error. Furthermore, these rates of degradation are heavily dependent on local environmental conditions and conveyed water type and thus require individual study. The accelerated acid degradation test for BVVPOA does not attempt to predict the rate of AC pipe degradation under variable environmental conditions; rather, it attempts to create a better understanding of the shape of the degradation rate curve and provide a credible estimate of remaining service life for samples collected as part of the project.

The chemical processes that degrade the AC pipe either leach out components of the cement material or penetrate the pipe wall to form products that weaken the cement matrix (Mordak and Wheeler 1988). This can be accomplished by using a nitric acid solution diluted at

different strengths. Sulfuric acid was also used in a trial run. However, ettringite formation due to sulfate attack caused expansion within the cement matrix that did not resemble any of the AC pipe samples which were obtained from the BVVPOA system. Therefore, nitric acid was selected for all accelerated acid testing.

4.2 Accelerated Acid degradation testing schedule

The accelerated acid testing was conducted in three phases. Phase I was conducted to determine the level of degradation that could be achieved within a reasonable amount of time for a single acid concentration. Phase II was conducted under various acid strengths to quantify the effect of acid concentration on the rate of degradation. Phase III was conducted to fully understand the shape of the degradation vs time curve for various acid concentrations.

4.2.1 Phase I Acid testing procedure

For Phase I of the acid testing, fourteen 400 mL solutions of 10% nitric acid solution (for example, 40 mL nitric acid and 360 mL water) were prepared. The pH was measured to ensure the solution in each bucket was of similar strength. Two groups, of seven AC pipe specimens each, were placed in individual buckets. Specimens were (3" by 3") sections of AC pipe that were cut from a 6" nominal diameter pipe. The first group consisted of specimens with degradation levels between 1-2% (very minimal degradation), and the second group included specimen with degradation levels between 24-25% (significant level of degradation). There was also a separate control group of samples with different levels of degradation placed in tap water.

The inside face and the edges of these coupons were coated with epoxy or plastidip to allow only external degradation. A depiction of a sample coated with plastidip after being pulled from an acid bath is presented in Figure 4-1. This was done since AC pipe samples from BVVPOA show only external degradation and to reduce the uncertainty in the direction of the

acid front advancement. All 14 coupons were inserted at the same time on day 0. One sample was pulled from each group (i.e., the group with minimal degradation and the group with significant degradation) at different exposure times. The specimen were pulled from the acid at 1, 7, 14, 28, 60, 100, and 180 days as depicted in Figure 4-2. Control samples that were placed in water were also pulled and tested in a similar fashion. The pH was also measured for each sample prior to pulling from acid.

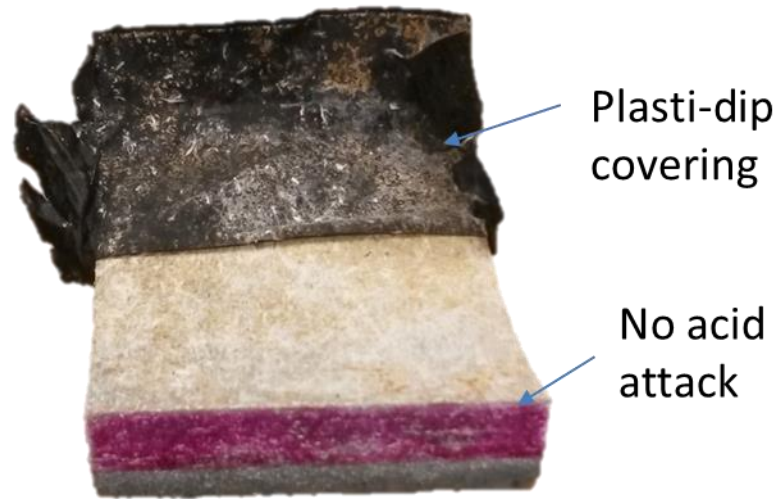

Figure 4-1. Plastidip protected sample after acid degradation

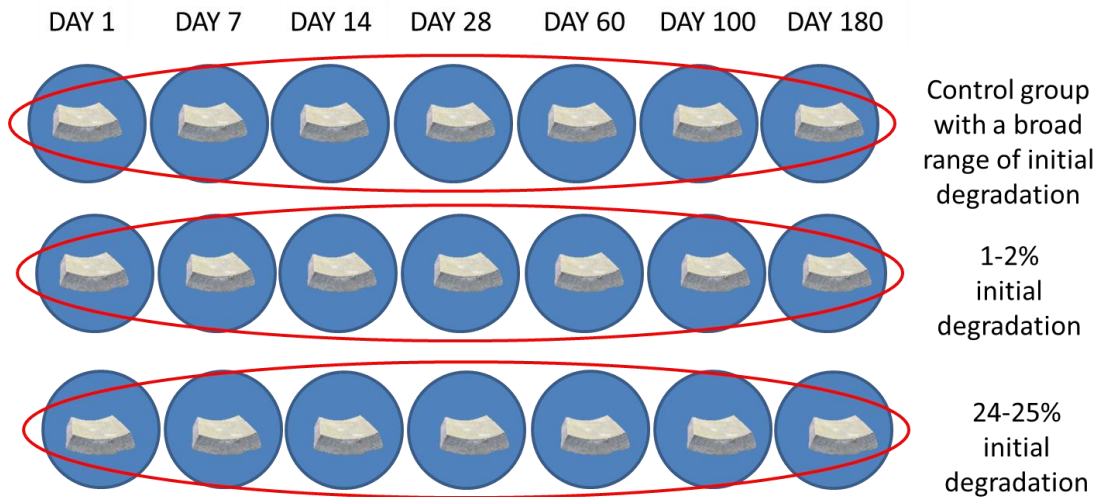

Figure 4-2. Phase I Acid Test set up

Once the coupon samples were pulled out of the acid solution and neutralized, a fresh surface is exposed for phenolphthalein testing. The level of degradation achieved at the specified exposure time is then recorded. Phase I of the acid testing schedule provides an understanding of the rate of degradation. By comparing data from both groups of samples tested in Phase I, a more comprehensive argument can be provided to validate the behavior of the rate of degradation on AC pipes.

4.2.2 Phase II Acid Testing Procedure

The obvious challenge to conducting accelerated acid testing is the issue of using high concentration acid to simulate relatively weak acid attack that occurs in soil environments as suggested by Davis et al. (2008). To mitigate this issue, a second phase of acid testing was conducted. Phase II solely focused on comparing the rate of degradation experienced by AC pipes under strong acid and weak acid solutions. A different method of measuring the level of degradation was employed, which did not include phenolphthalein staining since the degradation caused by the weak acids was not identifiable by phenolphthalein staining given the limited time span used in the experiment (i.e., the weak acids were not able to leach out sufficient lime in the time span required for this testing). Therefore, the specimen showed little to no change in degradation as measured by phenolphthalein staining.

With knowledge that degradation occurs through the leaching of lime from the cement matrix, a method of measuring the concentration of calcium ions in the acid solution was employed. Sample coupons were prepared similar to Phase I and the inside surface and edge of coupons was protected with plastidip. The coupons all had relatively similar level of degradation (around 20%). The acid concentrations values were 10%, 1%, 0.1%, and 0.01% nitric acid solution with a control, tap water solution, also included. There were triplicates of acid solution

(Figure 4-3) prepared for each acid strength. Fifteen mL samples of solution were taken at different exposure times similar to Phase I: 1, 7, 14, 28, 60, 100, and 180 days. The concentration of calcium in each solution is then measured and plotted for each acid strength as a function of exposure time. The calcium was separated from other ions in the solution by using a Metrohm 850 professional Ion Chromatograph (IC) as shown in Figure 4-3. For use in the IC, the 15 mL solutions were first diluted to a pH of 3, which is within the operating range of the IC. The diluted solution was then placed in the IC which characterizes all the ions in the solution. Through preliminary tests, Magnesium was also found to be a good indicator of the degradation trend for these samples. Therefore, Calcium and Magnesium were identified as ions of interest and future measurements focused on these two ions. By comparing the trends of all acid strengths, the issue of using accelerated acid degradation to study AC degradation behavior can be addressed. The pH was monitored in these samples as an option to monitor how lime leaching raises the pH. However, preliminary results showed that pH is not a viable means of measuring degradation trends since changes in the low pH levels ($\text{pH} < 1$) cannot be confidently measured.



Figure 4-3. a) Sample set up for Phase II b) Ion Chromatograph

4.2.3 Phase III Acid Testing Procedure

When considering accelerated acid degradation testing, it is important to ensure that the acid is not losing its degrading capability. The process of lime leaching, shown in Equation 1 below, cannot continue if the hydrogen atoms in the acid have been consumed. In addition, the rate of consumption would also change as the concentration of hydrogen atoms changes over time.



Therefore, the results from Phase I and II of the accelerated acid testing could be biased if the acid has lost its degrading capability through the progression of time. Phase III was set up with 5 different acid concentrations (20%, 10%, 1%, 0.1%, and 0.01 % nitric acid solutions) and a control (water) solution. The solution was renewed every week with 15 mL samples taken

before the AC pipe specimens were introduced and after the one week exposure time. The steps are further explained in Figure 4-4. This allowed the AC pipe specimens to be exposed to acid with the same level of degrading capability each week for the nine week period in which the testing was conducted. Withdrawing 15 mL of sample from the acid bath before the coupon was placed allows for any measurement corrections, since the solution might have initial calcium and magnesium introduced while preparing the solution. The initial measurements can be subtracted from the final measurements acquired after the AC specimen has been exposed to the acid bath for 7 days. The same Ion Chromatograph used in Phase II is also used in Phase III.

15 ml specimen taken then
switched to new acid bath

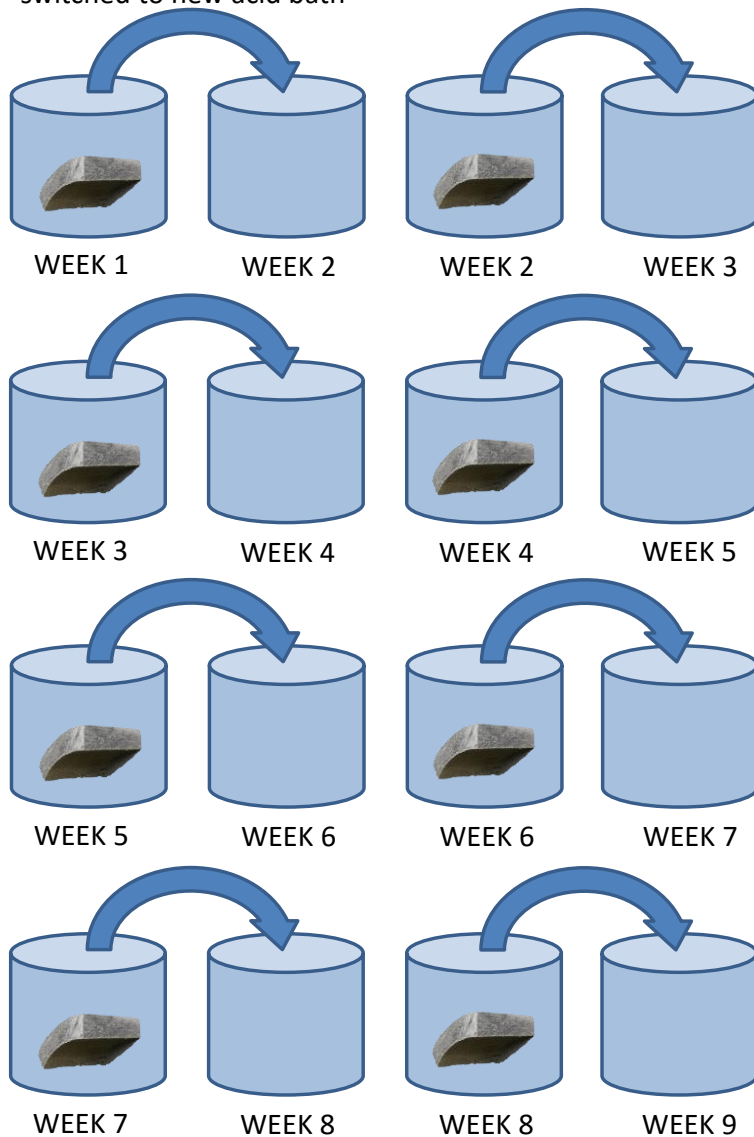

1. Desired strength acid bath is prepared (20%,10%,...)
2. 15 ml initial sample is taken
3. AC coupon is placed in acid bath
4. After coupon has been immersed for 7 days, 15 ml sample is taken
5. Second acid bath of similar strength is prepared
6. After taking initial 15 ml sample, coupon from the first acid bath (week 1) is now immersed in the second acid bath (week 2)
7. The process is repeated for 9 weeks.

Figure 4-4. Phase III acid test steps

4.3 Full Scale Acid Testing

Knowledge of the shape of the rate of degradation versus time plot for AC pipes can provide important information to predict future levels of degradation. This information needs to be coupled with knowledge of a threshold strength value. The threshold strength value is the critical strength value of AC pipes that corresponds with a level of degradation, beyond which

the pipe would fail to meet an acceptable factor of safety. Beyond the threshold level, the pipe may not be safe for operation and immediate remediation is recommended. While it is possible to extrapolate strength data to identify a threshold value, physical testing is required to validate this extrapolation. BVVPOA has provided samples from 23 locations, with a maximum level of degradation of 31%. Preliminary testing has showed that samples with up to this level of degradation adequately meet AWWA requirements (crushing and hydrostatic) for new AC pressure pipe. Since it is not expected that there are locations that are currently at critical levels of degradation where BVVPOA can sample from, acid solution is used to further degrade samples taken from BVVPOA. Samples with different levels of degradation were selected and degraded artificially to levels between 20-90% degradation. BVVPOA provided 12 (one foot) and 6 (four foot) samples from one location (Kinross Drive). This allowed for accelerated acid testing on samples with relatively similar levels of degradation and similar pipe chemical composition.

One foot samples are degraded artificially for crushing test specimens and four foot samples for hydrostatic test specimens. The inside and end edges of the one foot pipe specimens are coated with plastidip to protect from acid attack and ensure that degradation only occurred from the outside inwards. Plastidip was used instead of epoxy because the brittle nature of epoxy after it dries affects the strength values when tested. In contrast, the plastidip can easily be removed prior to running the crushing test.

General steps for preparation of one foot accelerated acid degraded samples

1. The initial degradation of the sample is measured and recorded along with any obvious physical anomalies that could affect the rate of degradation.

2. The inside and edges of the sample is then coated with plastidip to isolate acid attack to the outside surface of the sample.
3. 10% nitric acid solution is prepared in a 5 gallon bucket.
4. The one foot sample is then immersed in the acid bath.
5. After the desired amount of exposure time, the pipe is extracted and the surface is neutralized.
6. A fresh surface is exposed for phenolphthalein staining to allow for measurement of the extent of degradation.
7. The sample is then crushed and the residual strength recorded.

For the four foot acid samples, the ends of the pipe specimens are capped with fernco rubber end caps to prevent acid from entering the inside of the pipe. Coating the inside of the four foot pipes was not feasible, therefore fernco caps were used to seal the pipe. The pipes are first filled with water to help submerge them in the acid solution. They are then capped and immersed in 10% nitric acid solution and removed at different exposure times that correlate with the degradation levels listed above. Additional acid was used to achieve the desired degradation level for some cases. Both one foot and four foot samples were removed at the desired exposure time, neutralized and tested. A fresh surface was exposed for phenolphthalein testing to get an accurate level of degradation for the sample.

General steps for preparation of four foot accelerated acid degraded samples

1. Initial degradation was measured and recorded similar to the one foot sample.
2. Both ends of the sample were cleaned to create a smooth surface that allows for proper sealing between the fernco and the sample to prevent water leakage.
3. One end of the sample was sealed with fernco and the pipe was filled with water.

4. The other end was then sealed. This was done to insure the sample doesn't float in the acid bath.
5. 10% nitric acid solution was prepared in a 10 inch diameter PVC pipe that has a length of 6'. The total volume of solution used is 8.5 gallons.
6. The four foot sample was lowered into the acid bath for the desired duration of acid exposure.
7. The sample was then removed and the surface was diluted using water and baking soda (NaHCO_3).
8. The extent of degradation was measured by exposing a fresh surface for phenolphthalein staining.
9. The sample was then tested for hydrostatic capacity using methods described in Section 3.3.2.2.

The levels of degradation below 30% are used for comparison with naturally degraded samples. This was done because the use of acid to degrade these pipes in an accelerated fashion, might cause structural changes in the AC pipe that would not occur in naturally degraded pipes over decades in the ground. The results from highly degraded samples, can be used to obtain the critical level of degradation where the pipe has fallen below a threshold value where the pipe no longer meets the level of confidence required to continue using it.

4.4 Conclusion

The accelerated acid degradation program allowed for a better understanding of AC pipe behavior as degradation occurs over time. The three phases of accelerated acid testing were conducted using nitric acid solutions of varying concentration where the progression of degradation was monitored using phenolphthalein staining and the concentration of Calcium and

Magnesium ions measured using an ion chromatograph. These tests provide critical information regarding the shape of the degradation versus time curve for AC pipes, which can be used to estimate remaining service life of the pipe. In addition to the lab experiments, full scale 1 and 4 foot long 6 inch diameter specimens were exposed to a nitric acid solution to artificially degrade the specimen so threshold values of hydrostatic and crushing strength could be obtained for AC pipe. Results from these experiments were used to predict the future performance of AC pipe specimens taken from the BVVPOA water distribution system.

5 Condition Assessment Results

5.1 Introduction

A comprehensive assessment of the BVVPOA AC pipe water distribution system was conducted using methods described in Chapters 3 (Asbestos Cement Pipe Evaluation) and 4 (Accelerated Acid Degradation). Asbestos Cement pipe samples were taken from 23 locations within the BVVPOA water distribution system. This chapter presents results from non-destructive testing methods such as visual inspection, phenolphthalein staining, and hardness test which allow for an assessment of the extent of degradation as well as residual strength measurement (destructive) methods, which include pipe crushing and hydrostatic testing.

5.2 Non-Destructive Testing

Initial assessment of AC pipes involves visual inspection, phenolphthalein staining and hardness evaluations. These tests provide information as to the extent of degradation experienced by the sampled pipes. This section discusses the results from all three non-destructive testing methods.

5.2.1 Visual Inspection and Observations

After excavating the pipe samples from the BVVPOA system, the samples were delivered as two one foot and one four foot long sections of pipe wrapped in plastic. Upon initial inspection, most samples were free of noticeable deformations that could weaken the samples such as large cuts or gouges on the surface of pipes. However, the surfaces did have different shades of soil and stains on the exterior from being buried for multiple decades. There was a visible waffle pattern on the external portion of all samples as presented in Figure 5-1. This

pattern is part of the manufacturing process of AC pipe. There were no samples with obvious signs of degradation that were visible to the naked eye.



Figure 5-1. Sample 10B depicting the external surface of AC pipe

The two edges of the pipe were identified as top and bottom and marked accordingly then the sample name was also inked onto the sample. Identifying the top and bottom edges allowed for two separate measurements of degradations using phenolphthalein staining that can be used to assess the difference in degradation across a sample.

It can be observed from Table 5-1 that the cross-sectional properties of AC pipes varied significantly as is typically expected for AC pipe. The minimum outside diameter for 6 inch pipes sampled in the project was 7.04", while the maximum outside diameter was 7.42". The thickness of the 6 inch pipes also greatly varied with a minimum of 0.65" and a maximum of 0.78". The 8 inch pipes had less variability with a minimum and maximum outside diameter of 9.44" and 9.55", while the thickness had a minimum and maximum value of 0.87" and 0.90" respectively. These variations will affect the results from residual strength measurement and therefore are accounted for in the evaluation of the destructive tests discussed in further detail later in this chapter.

5.2.2 Phenolphthalein Staining

The phenolphthalein staining test was conducted on the end of each AC pipe sample examined in this study as described in Section 3.3.1.2. When a freshly ground cross section of the pipe is exposed to the phenolphthalein solution, portions of the pipe that are degraded remain gray (i.e., do not react). This is in contrast to sections of the pipe where free lime is present, which have a purple discoloration indicating these sections are not degraded. Therefore, the results from phenolphthalein staining presented below are used to describe the overall condition of the AC pipe (i.e., the percentage of the pipe that has been degraded). A summary of the degradation values is presented in Table 5-1 (note that the degradation values presented in Table 5-1 are only external degradation).

Samples collected from BVVPOA indicated no internal degradation was present in the BVVPOA water distribution system (Figure 5-2), suggesting that the conveyed water is not aggressive. The aggressivity of the conveyed water could not be calculated due to the lack of alkalinity data from the utility. However, minimal effort was put forth since the samples showed no internal degradation.

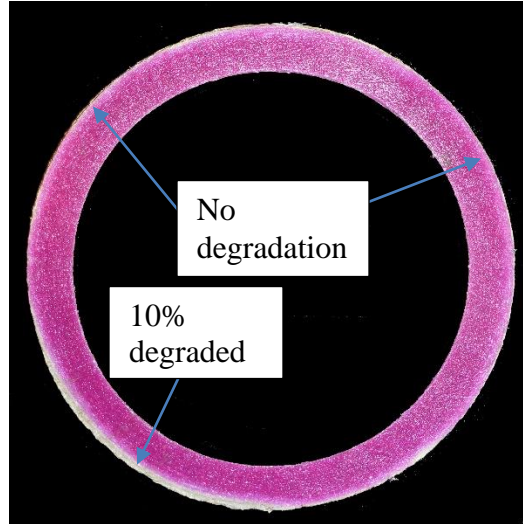

Figure 5-2. Surface showing no internal degradation and localized external degradation

Table 5-1. Phenolphthalein staining results from all sampled locations

Sample No.	Street Address	Type of Sample	Outside diameter (in)	Thickness (in)	Percent Degraded %	Degraded Thickness (in)	Average Degradation %
1	Windermere Lane	1'	7.33	0.74	15.21	0.11	12
		1'	7.32	0.76	11.4	0.08	
		4'	7.33	0.73	8.18	0.05	
2	Gainford Drive	1'	7.15	0.69	15.46	0.1	13
		1'	7.12	0.68	13.35	0.08	
3	Allonby Circle	4'	7.09	0.68	9.97	0.06	21
		1'	7.13	0.7	21.8	0.14	
4	Hexham Drive	1'	7.12	0.69	22.09	0.14	8
		4'	7.17	0.71	20.49	0.13	
5*	SunSet Drive	1'	7.15	0.68	9.65	0.06	1
		1'	7.13	0.7	7.59	0.05	
6	Churchill Drive	4'	7.14	0.68	5.46	0.03	18
		1'	9.55	0.89	0.41	0	
7	Wheybridge and Haslemere Ln.	1'	9.54	0.89	0.76	0.01	3
		4'	9.55	0.9	1.48	0.01	
8	Orchid Tree Lane	1'	7.18	0.71	12.05	0.08	5
		1'	7.22	0.72	21.02	0.15	
9	Stevenson Lane	4'	7.23	0.7	20.23	0.13	23
		1'	7.17	0.72	4.71	0.03	
10	Wheybridge Drive	1'	7.12	0.69	2.27	0.01	2
		4'	7.09	0.67	3.18	0.02	
11	Cawood Drive	1'	7.18	0.71	5	0.01	3
		1'	7.16	0.7	3.03	0.02	
12	Letchworth Drive	4'	7.18	0.7	7.18	0.04	3
		1'	7.18	0.68	20.91	0.13	
13	Southport Lane	1'	7.18	0.73	24.67	0.16	15
		4'	7.35	0.73	22.99	0.15	
14	Bolton Lane	1'	7.12	0.69	1.73	0.01	18
		1'	7.13	0.69	2.2	0.01	
15*	North Rillington Drive	4'	7.12	0.69	2.98	0.02	7
		1'	7.18	0.71	3.14	0.02	
16*	South Rillington Drive	1'	7.19	0.71	1.82	0.01	4
		1'	7.19	0.72	1.09	0.01	
17	Chelmsworth Circle	4'	7.18	0.71	3.91	0.03	31
		1'	7.21	0.72	2.37	0.02	
18**	Cooper Road	1'	7.18	0.71	5.63	0.04	26
		1'	7.19	0.72	1.09	0.01	
19	Camden Road #1	1'	7.19	0.72	2.37	0.02	4
		4'	7.18	0.71	5.63	0.04	
20	Camden Road #2	1'	7.18	0.73	3.18	0.02	3
		1'	7.18	0.73	3.18	0.02	
21	Midenhall Drive	1'	7.18	0.73	3.18	0.02	8
		1'	7.18	0.73	3.18	0.02	
22	Glemsford Drive	1'	7.18	0.73	3.18	0.02	5
		1'	7.18	0.73	3.18	0.02	
23	Kinross Drive	1'	7.18	0.73	3.18	0.02	9
		1'	7.18	0.73	3.18	0.02	

*Sampled pipe has a nominal 8" diameter
 **Cooper Road Sample 18 is from a live tap coupon

In Figure 5-2, the difference in degradation level across the pipe cross-section is shown. It can be observed that there is minimal to zero degradation across the majority of the pipe except on the lower left portion of the figure, which has approximately 10% of the thickness degraded. Based on the information provided, it is unclear what causes this difference across the pipe cross-section. The AC pipe could have less lime in those areas of the pipe from as a result of the manufacturing process, the bedding condition might allow for more water seepage to that portion of the pipe, or it could also be the orientation of pipe burial. However, not enough information was available to determine the exact cause of the cross section variation of degradation observed on some AC pipe samples.

The level of degradation determined by phenolphthalein staining was measured directly using digital calipers where the transition between degraded and non-degraded portions of the pipe was determined by eye. In addition, photos of the cross sections of the pipe were used along with an image processing Matlab script to determine the percent degradation based on color values of individual pixels in the image. Comparing the results between the methods, it is clear that certain samples had less contrast between the non-degraded (purple) area and the degraded (gray) area, which was not consistent around the cross section of the pipe as presented in Figure 5-3. The gradient area with light purple discoloration had enough lime leached from the surface that it didn't fully react with the phenolphthalein solution, therefore, creating a light purple discoloration. This could be better explained with the understanding that the phenolphthalein reaction occurs in AC pipes surfaces that have a pH greater than 8.3. Therefore, the leaching of small amounts of lime might have dropped these transition surfaces to a pH closer to 8.3 resulting in a light discoloration rather than a bright discoloration. However, further testing

(hardness check) showed that there was no AC softening that occurred in these transition areas with light purple discolorations. Therefore, the light purple areas should be included in the non-degraded portion of the pipe rather than the degraded portion. These findings are in agreement with the findings of Nebsar and Riley (1983) that suggested that the lime leaching agents are capable of removing the lime in advance of the pipe surface turning into soft AC. Harris and Radlinski (2012) also noted that the loss of strength in AC pipe lags behind the degradation front identified by the phenolphthalein solution.

Comparison between the two methods shows considerable variance for some pipe samples as presented in Figure 5-4. The Matlab script wrongly identified these non-degraded surfaces with light purple discoloration as degraded, hence overestimating the extent of degradation. These transition areas can be accounted for when using a digital caliper manually. For this reason and the simplicity of the manual measurement method, all reported degradation values were obtained using the manually measurement method.

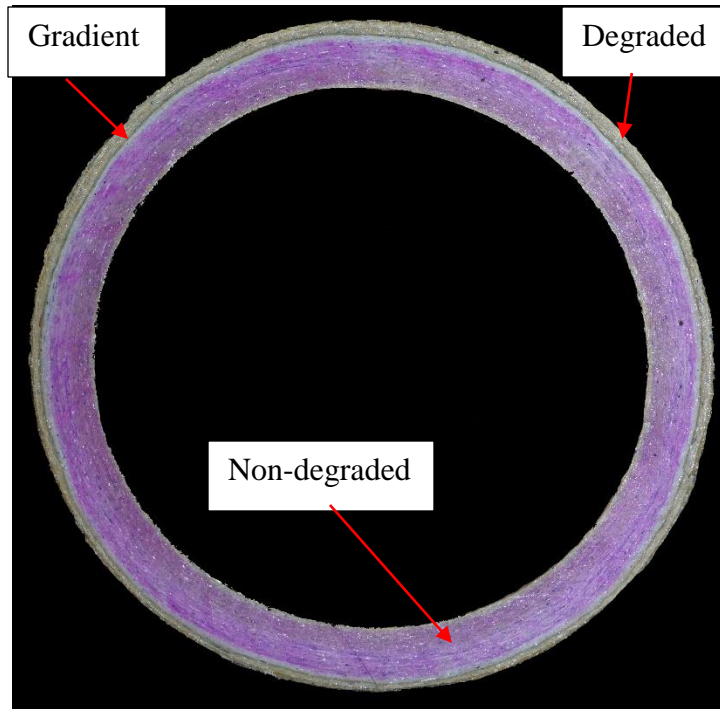

Figure 5-3. Sample with gradient between degraded and non-degraded front

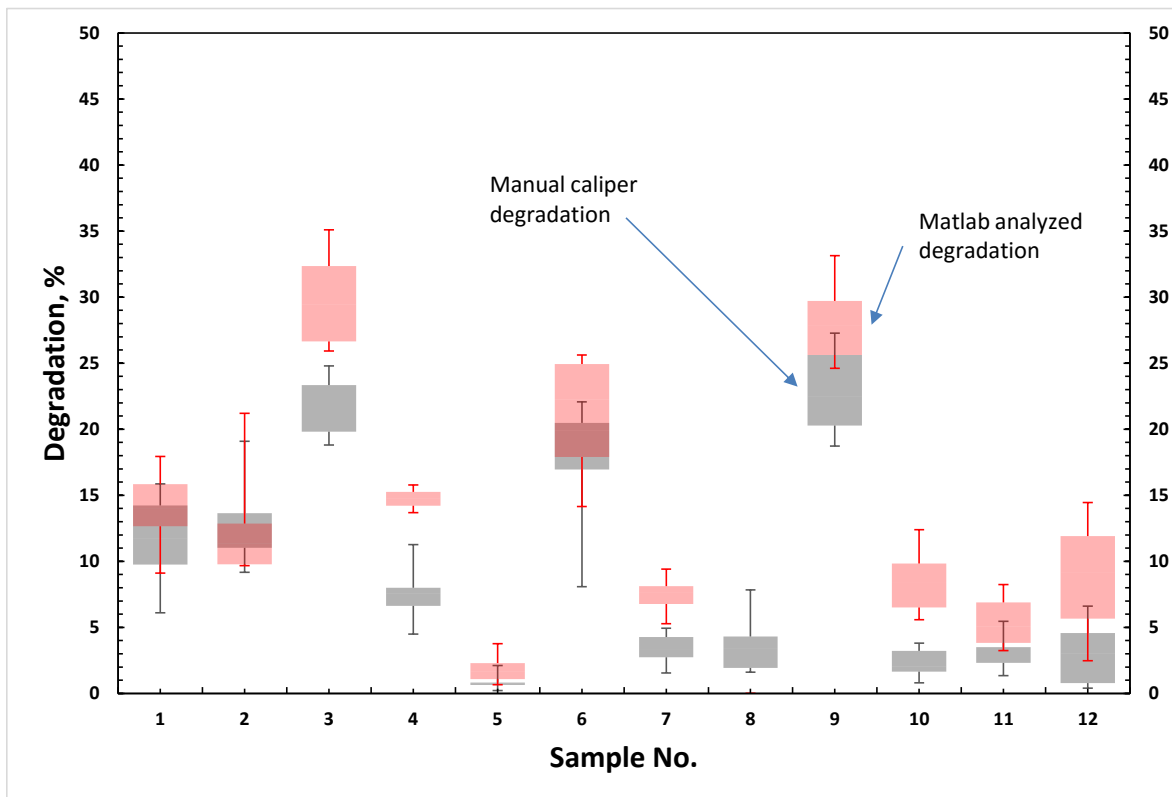

Figure 5-4. Comparison between Manual and Matlab degradation measurements

The variation in degradation levels measured at each sampling location (i.e., both ends of each pipe sample can be measured allowing six degradation measurements for each sampling location) is another point of interest from Figure 5-4. For example, Sample 6 from Churchill Dr. has a minimum degradation of 8% and a maximum degradation of 22% measured manually. This suggests that the difference in extent of degradation can be highly variable along a 6' section of AC pipe. The difference in soil aggressivity is not as highly pronounced in other locations, but there is still some level of variation in the level of degradation measured for each location. The individual degradation value for each pipe was used when comparing crushing and hydrostatic strengths. However, the reported degradation values at each location were determined by averaging the results from the two one foot and one four foot section.

The overall results from phenolphthalein tests indicate that the BVVPOA utility has a highly varying level of degradation throughout the system (1-31%) as presented in Figure 5-5. The variable degradation shown in Figure 5-5 is attributed to the variation in the external conditions surrounding the pipe. Similar variations were observed by Hu et al. (2013); Harris and Radlinski (2012); Chowdhury et al. (2012); and Slaats et al. (2004). The minimum reported was 1 % at Sunset Drive (Sample 5), while the maximum was recorded at Chelmsworth Circle (Sample 17) with 31% degradation (a difference of 30%). It is difficult to unequivocally state the reason for the difference in degradation for pipes of the same size within a utility without a thorough site analysis to understand the aggressivity of the soil at each location

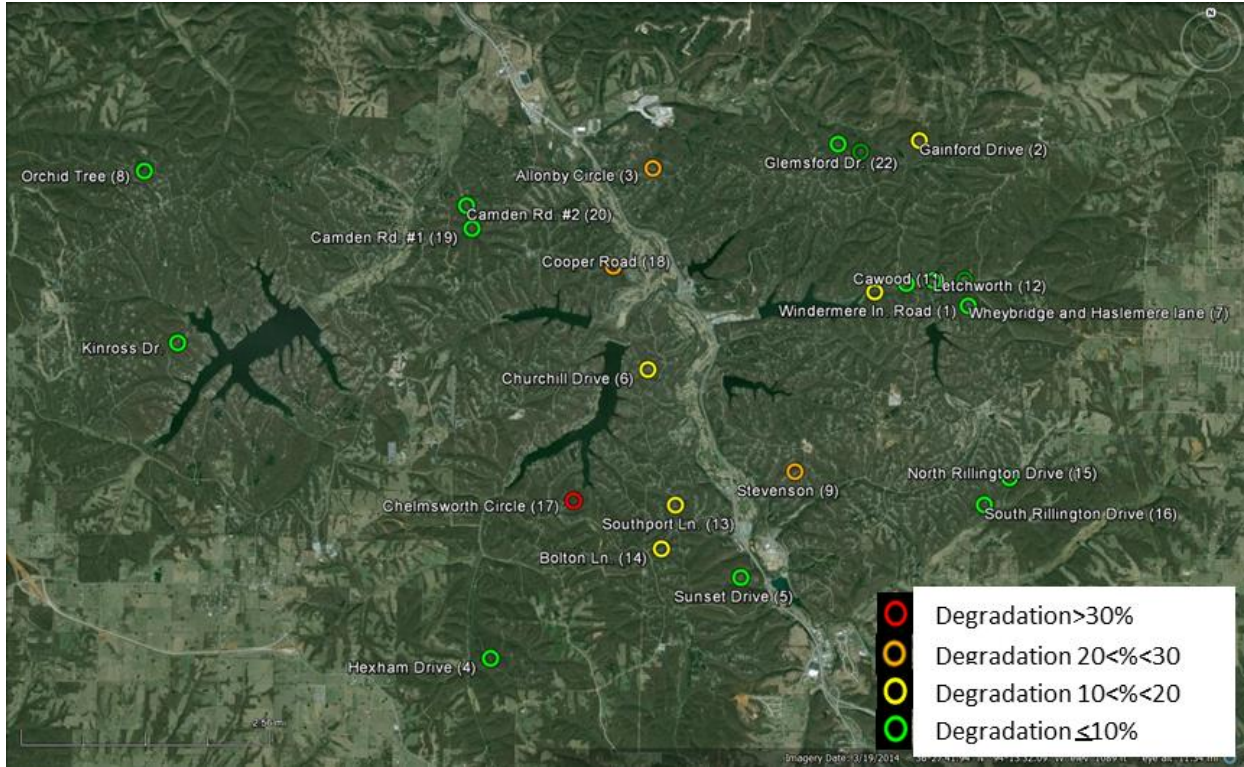

Figure 5-5. Sampling locations with highlighted levels of degradation

The scatter in the level of degradation in BVVPOA water system can be presented more clearly using the bar graph in Figure 5-6. The majority (83%) of the AC pipes sampled in BVVPOA have measured degradation less than 20% and 61% of the samples with less than 10% degradation. This leaves only 4 samples or 17% of the samples with greater than 20% degradation. Given the approximately 40 year service life of many of the AC pipes in BVVPOA, this suggests that the external environment in BVVPOA is only slightly to moderately aggressive to AC pipe.

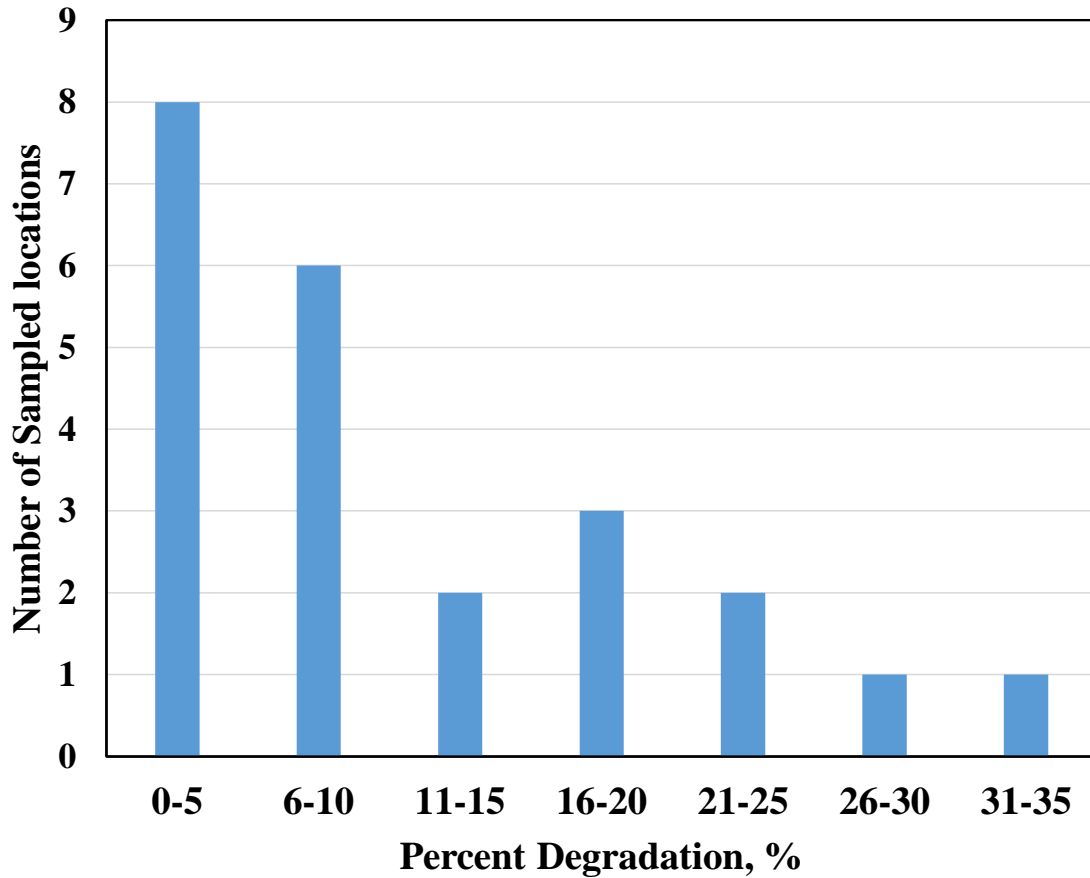

Figure 5-6. Degradation level distribution among sampling locations

5.2.3 Hardness test

The hardness test is conducted across the cross section of the pipe wall following methods described in Section 3.3.1.3. Shore D durometer test performed on samples of different degradation levels reveal that the degraded portion has differing levels of hardness depending on the extent of leaching. There is an increasing hardness trend as the testing was conducted on the cross section from the degraded to non-degraded portion of the pipe as presented in Figure 5-7. Repeated tests indicate that a Shore D hardness level of greater than 85 can be classified as non-degraded. Therefore, the degradation front in areas with low contrast between degraded (gray)

and non-degraded (purple) portions (as detailed in the previous section) can be identified using this test. The Hardness test reveals that the loss of lime, highlighted using the phenolphthalein test, does result in creation of soft AC. It also proves the suspicion that the loss of strength lags behind the degradation front as noted by Denison and Romanoff (1951) and Harris and Radlinski (2012). For all the AC pipe samples tested, the hardness value was determined to be the lowest on the outside face and tends to stay constant at the middle and inside face of the AC pipe sample. In contrast to Hu et al. (2013) and Chowdhury et al. (2012), who reported higher hardness values on the outside surface than the middle surface, there were no hardening effects (due to certain chemical reactions) on the degraded outside surface of the tested AC pipe sampled from BVVPOA.

Shore D Durometer Hardness measuring device.



The pin was fully inserted into the pipe and a reading was taken at each of the spots across the face of the pipe sample beginning at the degraded face.

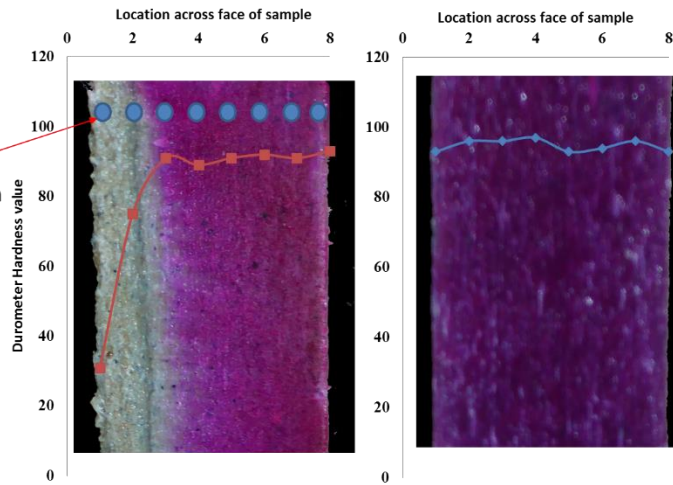

Figure 5-7. Shore D Durometer Test on degraded (left) and non-degraded (right) samples

The results from the hardness test show that phenolphthalein staining is a viable method of measuring the level of degradation. Although the extent of AC softening might not be the same throughout the degraded portion, the phenolphthalein staining method provides a conservative method of measuring the level of degradation by considering all of the gray portion (degraded) as unable to support any load.

5.3 Destructive Testing

Visual inspection, phenolphthalein staining, and hardness test allow for an understanding of the extent of degradation experienced by AC pipe samples. Destructive testing which includes crushing and hydrostatic testing enables the measurement of residual strength. This residual strength data can be used in correlation with extent of degradation to better understand AC pipe strength at different levels of degradation.

5.3.1 Crushing strength

Samples collected from BVVPOA that were one foot in length were tested for transverse vertical load capacity using the crushing test procedure detailed in Section 3.3.2.1. The pipes were gradually loaded until failure and the failure loads were recorded. The failure load for each test was divided by the length of the sample to give a unit load per foot value. The samples all failed at crushing loads higher than the AWWA specified design load of 5,400 lb/ft for 6” pipe and 5,500 lb/ft for 8” pipe (AWWA C400 2003). A factor of safety was calculated accordingly for all tested samples by dividing failure load by the design load as presented in Figure 5-8. Most (83%) samples had factors of safety greater than 1.6 which agrees with results from phenolphthalein staining test, which suggest the majority of pipes from the sampled locations are slightly to moderately degraded and have not lost a significant portion of their initial strength. Chelmsworth Circle (Sample 17), which exhibited the highest levels of degradation also had the lowest factor of safety (1.18).

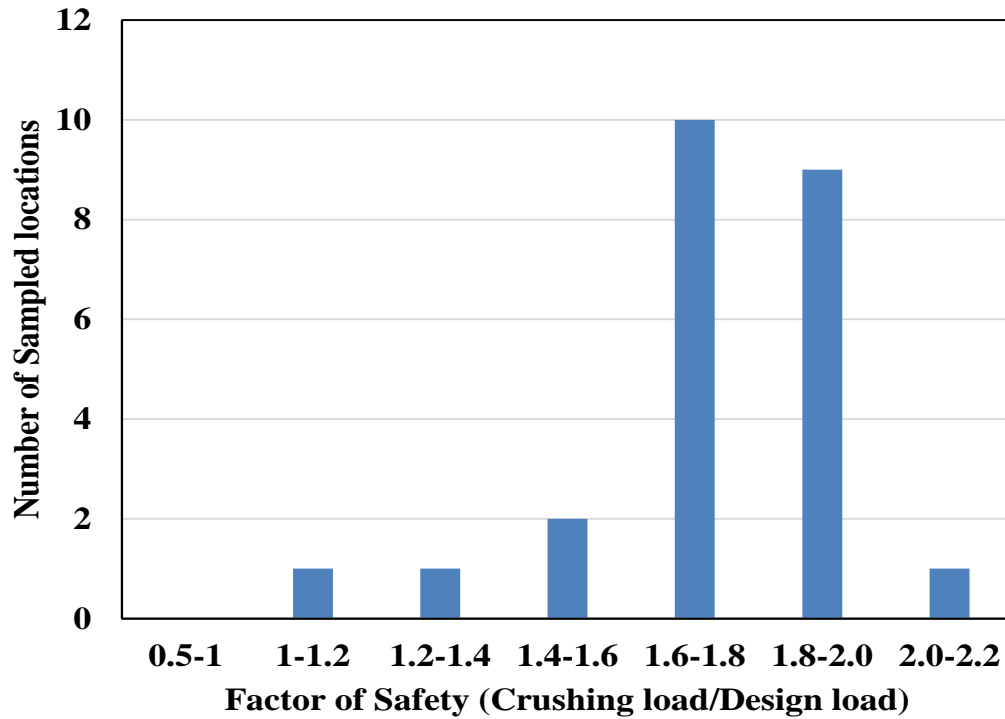

Figure 5-8. Factor of Safety against crushing for all tested samples

As presented in Figure 5-9, the failure load can be plotted against degradation for both natural samples and accelerated acid degraded samples to better understand the relationship between degradation and crushing strength. This plot highlights the importance of accelerated full scale acid testing to provide samples with degradation levels higher than 30% to better understand the effects of degradation on crushing strength. Acid samples with less than 30% degradation were observed to be within 15% crushing strength of samples with similar degradation levels degraded naturally. The acid samples depicted in red diamond shape were part of the full scale acid testing which is discussed in detail later. For now the focus should be that both acid and naturally (buried in the soil) degraded pipes have similar crushing strengths at similar degradation levels.

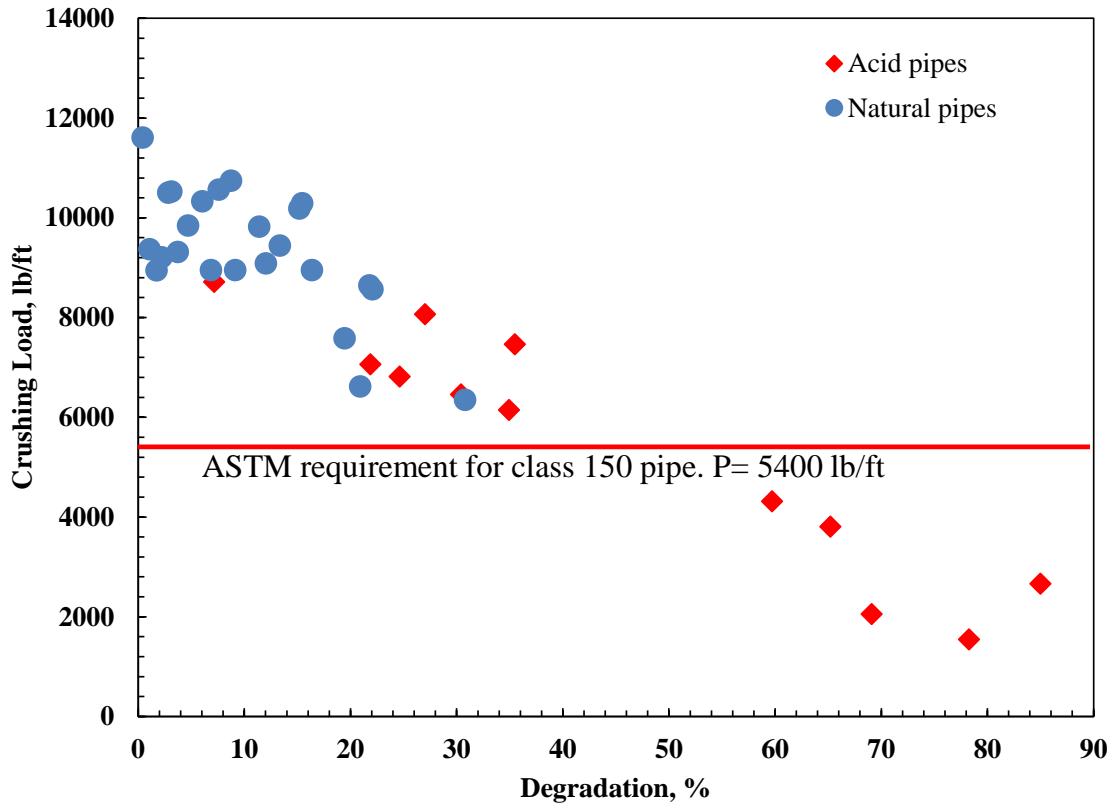

Figure 5-9. Crushing load vs degradation with AWWA requirement shown

From Figure 5-9, there is no apparent drop in crushing load with an increase in degradation up to degradation values of 15%. There is a visible linear drop in crushing load beyond the 15% mark; however, using this data to develop a trend line without first correcting for the differences between the outside diameter and thickness of the pipe sample would lead to erroneous results. Therefore, the rupture modulus was calculated for all data points presented in Figure 5-9 using Equation 5.1 (Denison and Romanoff 1951).

$$\text{Rupture Modulus} = \frac{0.9 \cdot P(d+t)}{t^2} \quad 5.1$$

Where P is the failure load in lb/ft, d is the internal diameter of sample in inches and t is the thickness of pipe in inches. Rupture modulus calculations allow for consideration of differences in pipe cross-sectional properties such as diameter and thickness when comparing

crushing failure loads of AC pipe samples. Similar to the crushing load plot, the rupture modulus plot presented in Figure 5-10 depicts all samples having higher rupture modulus values than AWWA requirements apart from some acid degraded samples. The data points from acid testing are included as one set of data together with the naturally degraded pipes in the rupture modulus calculations. It can be observed that there is more scatter in the data below 15% degradation unlike the crushing load plot. A linear trend line has a coefficient of determination of 0.85, which suggests a good correlation between degradation and loss of strength.

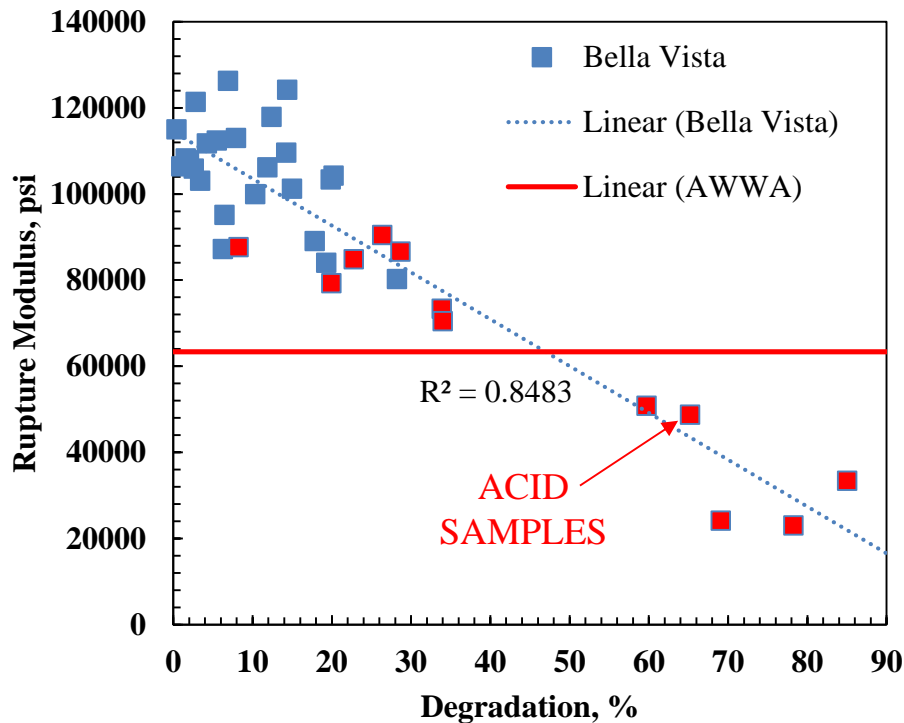

Figure 5-10. Rupture Modulus calculated from crushing load plotted against degradation

Due to limitations on the amount of acid samples that can feasibly be produced, data from Hu et al. (2013) was added to increase the robustness of the correlation between rupture modulus and degradation and serve as comparison point for samples degraded using accelerated acid program. The rupture modulus values from Hu et al. (2013) for samples with less than 30%

degradation seem to agree reasonably well with data from BVVPOA (Figure 5-11), although there is a much larger scatter in the Hu et al. (2013) data. The level of scatter in the data requires the use of a 95th percentile line to determine a level of threshold degradation that can be used as a point of reference. The 95th percentile line serves as a conservative approach to determining the point where AC pipe will not perform to the level required by AWWA specifications. This point determined using the data in this study and the Hu et al. (2013) data is 32% degradation.

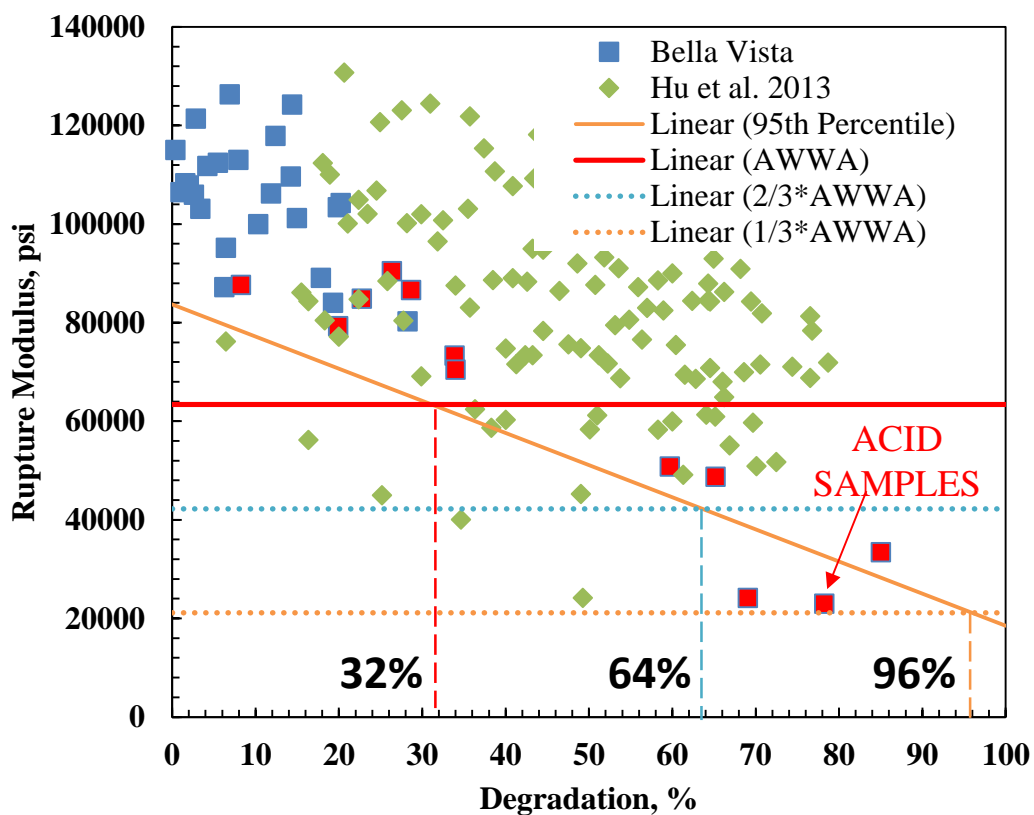

Figure 5-11. Rupture Modulus values from samples taken from BVVPOA and Hu et al. (2013) report along with the 95th percentile AWWA intersection shown.

However, since the AWWA requirements are for newly manufactured pipes, 2/3 and 1/3 of AWWA requirements were considered for the rupture modulus. These levels provide for much higher critical levels of degradation. For the purposes of this research AWWA was chosen as the controlling requirement to be met, since it allows for a conservative approach. However,

further research is required to determine the most appropriate failure criterion. There is high scatter in the Hu et al. (2013) data. For example, for two data points with 35% degradation there is a 67% difference in rupture modulus between the two samples. However, it should be noted that AC pipe samples tested by Mordak and Wheeler and Hu et al. (2013) showed both internal and external degradation. Both authors assumed the total degradation to be a simple summation of internal and external degradation. This could be the source of error when they attempted to compare crushing test results with different levels of degradation. The loaded pipes generally failed at the 12 and 6 o'clock positions first, followed almost immediately by cracking at the 3 and 9 o'clock positions as noted by Mordak and Wheeler (1988). The failures at the 12 and 6 o'clock position began at the inner portion of the pipe while the 3 and 9 o'clock position cracks began on the outer portion of the pipe. The difference in the level of degradation on the internal and external portions of the pipe could have significant effects on the rupture strength of the pipe. For example, a sample (Example 1 shown in

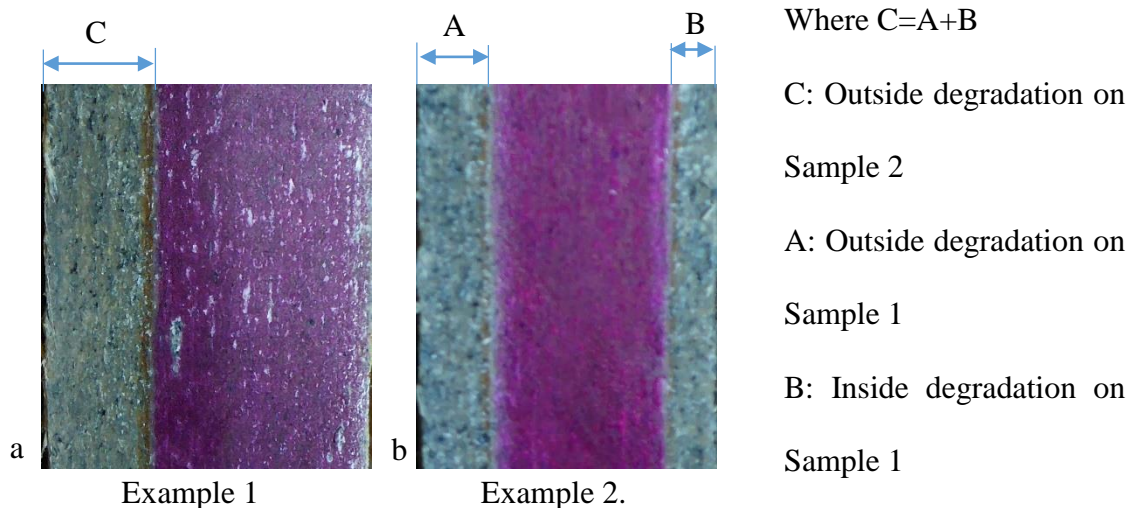
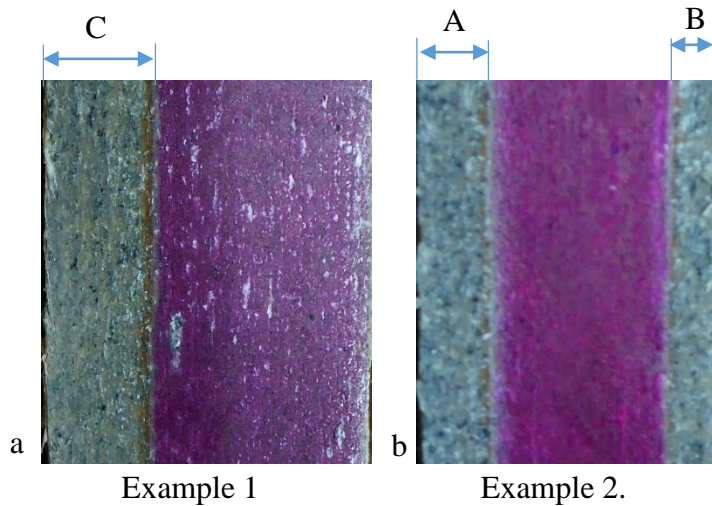

Figure 5-12-a) of pipe with significant degradation on the outside surface only, is wrongly equated to having a similar level of degradation as a sample (Example 2 shown in



Where $C=A+B$

C: Outside degradation on Sample 2

A: Outside degradation on Sample 1

B: Inside degradation on Sample 1

Figure 5-12-b) having a lesser level of degradation on the outside surface but which also has degradation on the inside surface which would add up to a total degradation equal to the first sample. These two samples would have similar levels of degradation under this assumption; however, the crushing strength for Example 1 is expected to be higher since the crack begins on the inside (non-degraded) face of the sample as opposed to Example 2 where the crack begins on the inside (degraded) face of the sample. The internal degradation in Example 2 will result in the initial 12 and 6 o'clock cracks (which form on the inside face) to form at a lower crushing load than Example 1.

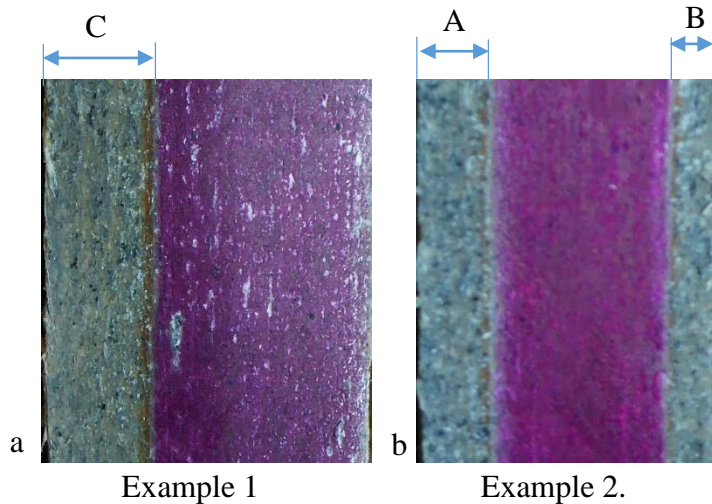

Where $C=A+B$

C: Outside degradation on Sample 2

A: Outside degradation on Sample 1

B: Inside degradation on Sample 1

Figure 5-12. Sample with external degradation compared with sample with degradation on both sides

5.3.2 Hydrostatic strength

Samples four foot in length were tested hydrostatically using the procedures described in Section 3.3.2.2. The pressure at which the four foot pipes failed at was recorded and plotted against the level of degradation of the sample as presented in Figure 5-13 and tabulated in Table 5-2. All tested samples failed at pressures above the minimum AWWA requirements. The maximum operating pressure reported by the utility was 140 psi, which is 4.6 times lower than the lowest failure pressure recorded from Stevenson Lane. The maximum failure pressure was 972 psi recorded at Orchid Tree Lane (Sample 8) while the minimum was 644 psi recorded at Stevenson Lane (Sample 9). Similarly to the crushing data a factor of safety against AWWA requirements was calculated and presented in Figure 5-14. Sample 9 from Stevenson Drive and Sample 14 from Bolton Lane had factors of safety between 1.0-1.2, while others had factors of safety greater than 1.2. This suggests that the environment around the samples from BVVPOA did not cause significant degradation that would result in lower hydrostatic resistance than that stipulated by AWWA.

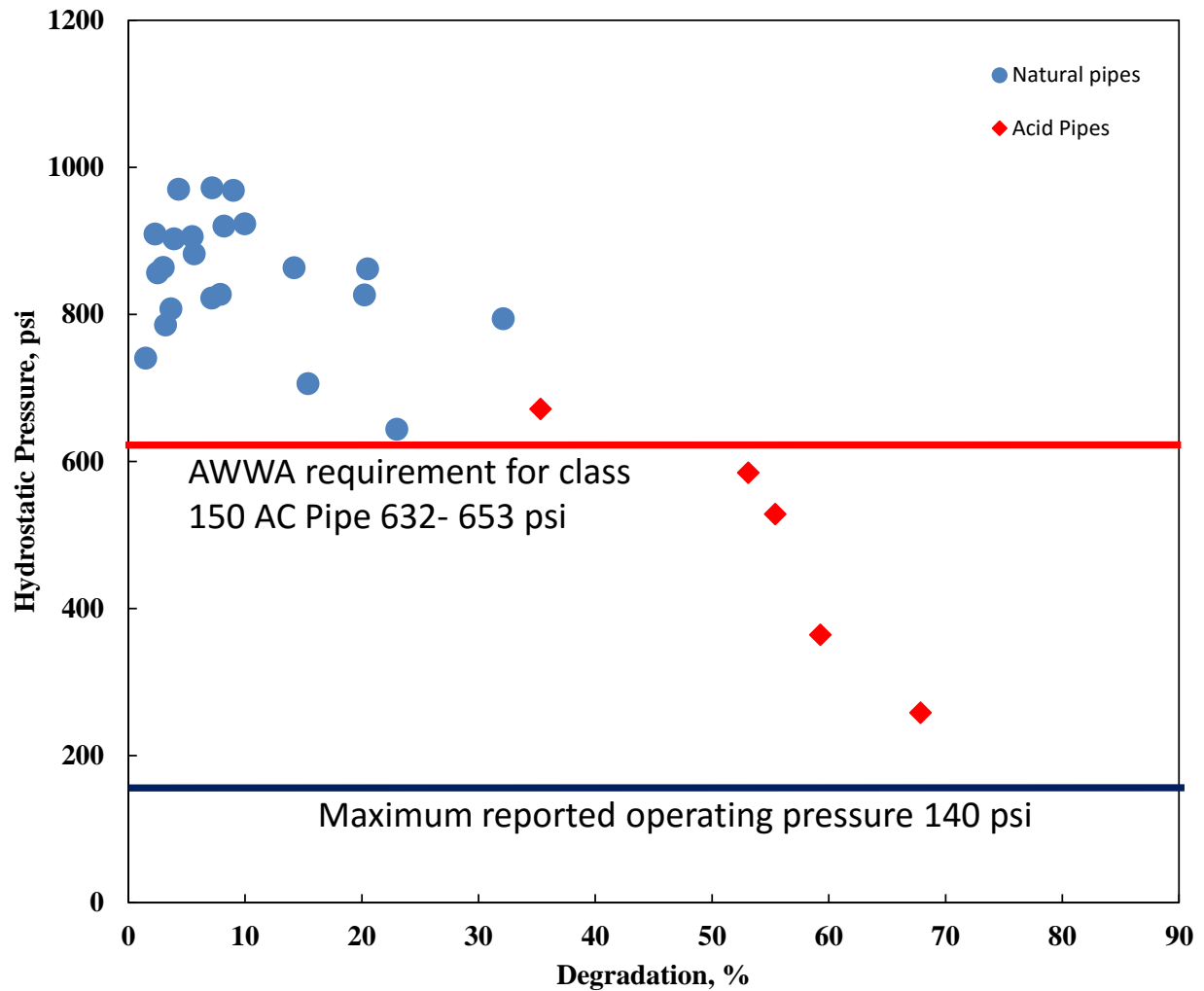

Figure 5-13. Hydrostatic Pressure values for all tested samples (6" and 8")

It can be observed from Figure 5-13 that there is no significant drop in hydrostatic strength up to 15% degradation. However, increase in degradation results in decrease in hydrostatic strength beyond 15% degradation. This is in agreement with data from crushing tests which resulted in a linear decrease in crushing strength as a function of degradation beyond 15% degradation. This would suggest that the resistance capacity of AC pipe is not affected by levels of degradation below 15%. A possible explanation for this could be that all samples from BVVPOA only exhibit external degradation. Therefore, the internal portion of the pipe where

cracks initially form and propagate has not been compromised and remains integral. Beyond this 15%, degradation the structural integrity of the pipe is under question, since a significant portion of the thickness of the pipe turns into soft AC.

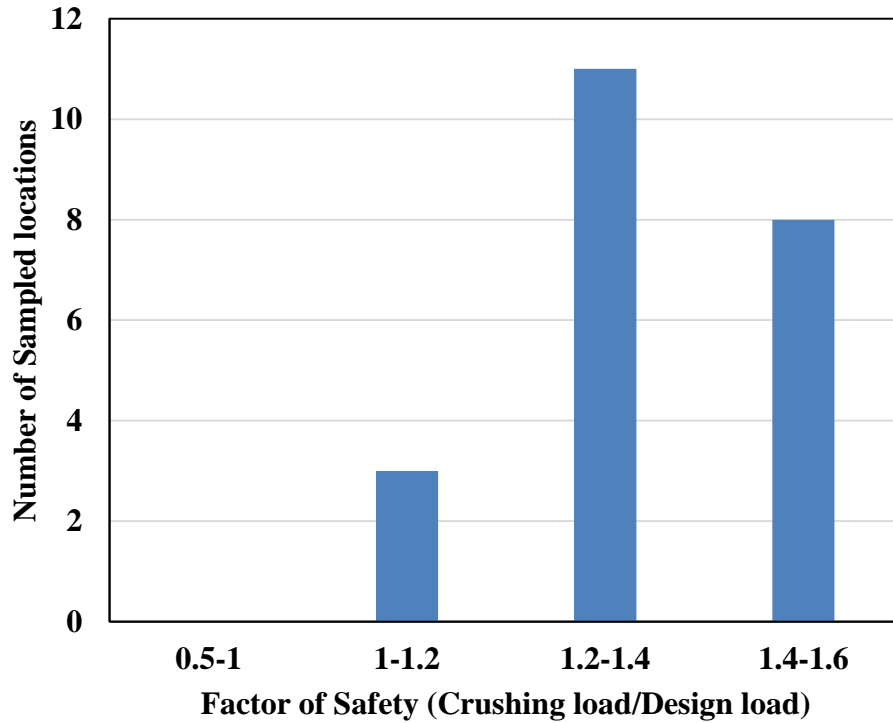

Figure 5-14. Bar graph depicting the factor of safety for hydrostatically tested samples

The hydrostatic data is also affected by the difference in cross-sectional properties of the tested pipes. The same procedure of incorporating data from Hu et al. (2013) can be used to complement missing data in the high degradation range. Tensile strength can be calculated as a measure of resistance to hydrostatic pressure according to Equation 5-2 (Denison and Romanoff 1951). The tensile strength versus degradation plot is presented in Figure 5-15.

Equation 5-2:

$$\text{Tensile strength} = \frac{P(d + 1.7 * t)}{2 * t}$$

Where P is the Hydrostatic bursting pressure in psi, d is the internal diameter of sample in inches and t is the thickness of pipe in inches. Sample 9 from Stevenson Drive falls just below the AWWA line when taking the diameter and thickness into consideration. However, the sample is still over 4 times the reported operating pressure.

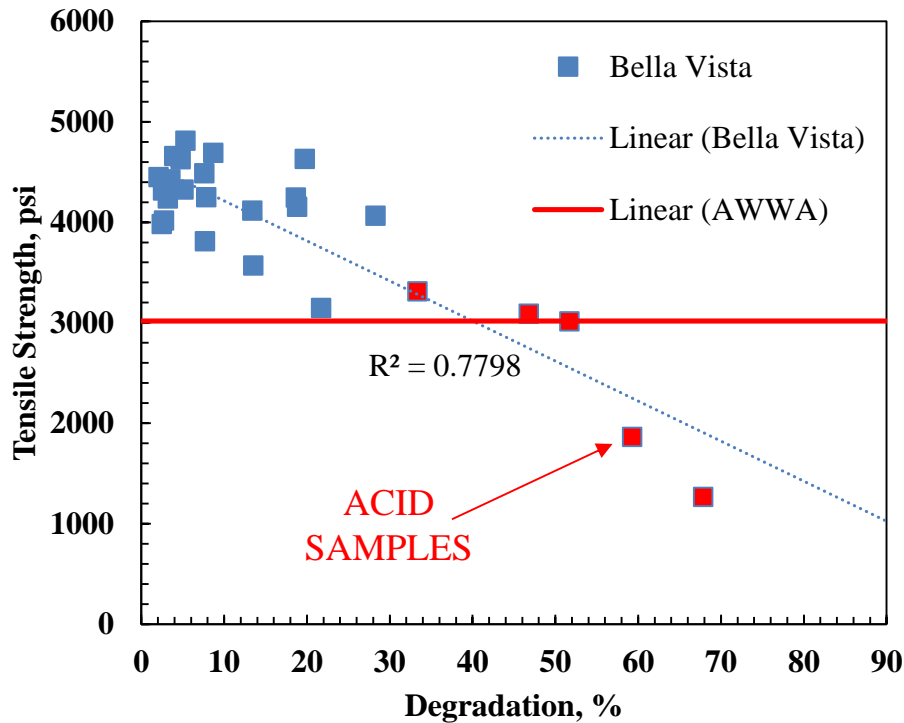

Figure 5-15. Tensile strength calculated from hydrostatic data which accounts for differences in pipe thickness and diameter

A coefficient of determination of 0.78 suggests that there is a reasonably well correlation between degradation and loss of strength as was seen from the crushing data. There is insufficient data for degradation levels greater than 50%. Therefore, the same method as the rupture modulus plot of using the 95th percentile line on the data points from both BVVPOA and Hu et al. (2013) was applied for the tensile strength data set as presented in Figure 5-16. The intersection of the 95th percentile line with the AWWA line provides a 32% degradation level after which the sample will not perform better than AWWA stipulations.

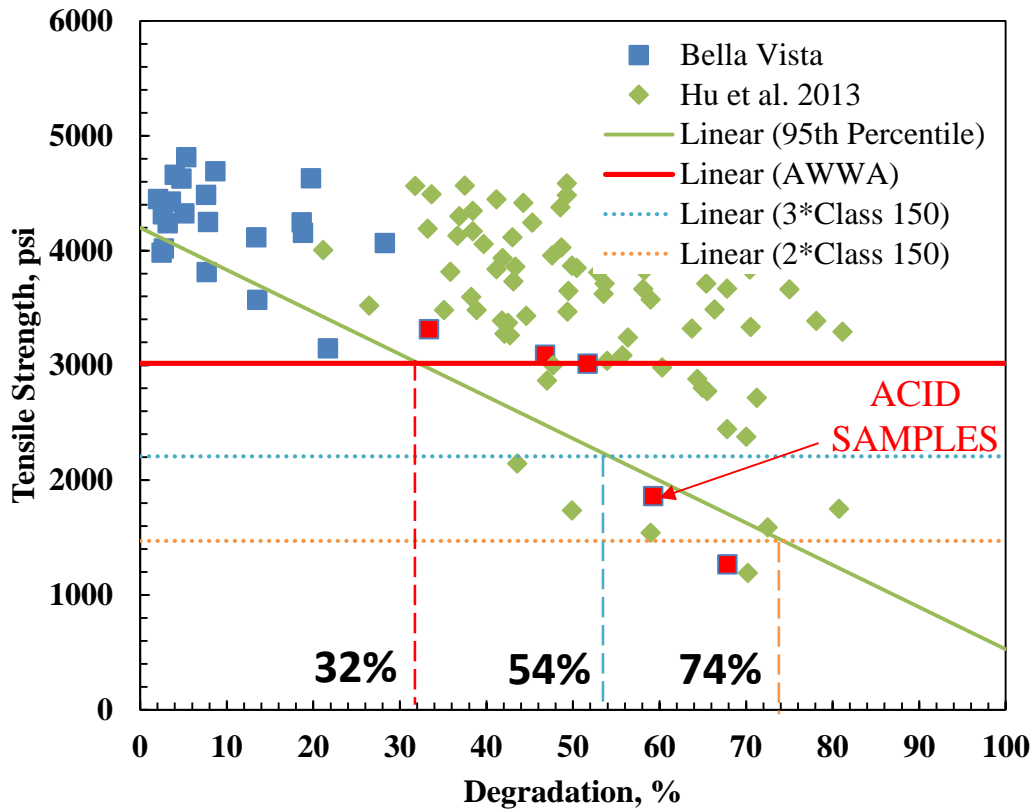

Figure 5-16. Tensile strength from Hu et al. (2013) and Bella Vista with AWWA and 95th percentile intersection shown

Tensile strength values corresponding to two and three times class 150 requirements (150 psi) are also included in this plot for reference. Similarly to the rupture modulus data where 1/3 and 2/3 of AWWA requirements yielded higher degradation levels the two and three times class 150 pipe requirements also allow for higher degradation limits. However, AWWA was chosen since it provides a conservative approach for this research. A summary of all tested pipes is presented in Table 5-2. The sampled street name along with cross-sectional properties, level of degradation, crushing load and hydrostatic data is included in this table. It should be noted that there is no hydrostatic pressure value for Sample 5 from Sunset Drive, since the cast iron end caps blew off prior to pipe failure at around 740 psi.

Table 5-2. Summary table of collected samples and test results.

Sample No.	Street Address	Type of Sample	Outside diameter (in)	Thickness (in)	Percent Degraded	Degraded Thickness (in)	Average Degradation %	Crushing Load (lb/ft)	Average Crushing Load (lb/ft)	Hydrostatic Pressure (psi)
1	Windermere Lane	1'	7.33	0.74	15.21	0.11	12	10185	10002	920
		1'	7.32	0.76	11.4	0.08		9820		
		4'	7.33	0.73	8.18	0.05				
2	Gainford Drive	1'	7.15	0.69	15.46	0.1	13	10288	9865	923
		1'	7.12	0.68	13.35	0.08		9442		
		4'	7.09	0.68	9.97	0.06				
3	Allonby Circle	1'	7.13	0.7	21.8	0.14	21	8642	8604	862
		1'	7.12	0.69	22.09	0.14		8567		
		4'	7.17	0.71	20.49	0.13				
4	Hexham Drive	1'	7.15	0.68	9.65	0.06	8	10563	10563	905
		1'	7.13	0.7	7.59	0.05				
		4'	7.14	0.68	5.46	0.03				
5* ¹	SunSet Drive	1'	9.55	0.89	0.41	0	1	11606	11606	
		1'	9.54	0.89	0.76	0.01				
		4'	9.55	0.9	1.48	0.01				
6	Churchill Drive	1'	7.18	0.71	12.05	0.08	18	9086	9086	826
		1'	7.22	0.72	21.02	0.15				
		4'	7.23	0.7	20.23	0.13				
7	Wheybridge and Haslemere Ln.	1'	7.17	0.72	4.71	0.03	3	9844	9844	785
		1'	7.12	0.69	2.27	0.01				
		4'	7.09	0.67	3.18	0.02				
8	Orchid Tree Lane	1'	7.18	0.71	5	0.01	5	9208	9208	972
		1'	7.16	0.7	3.03	0.02				
		4'	7.18	0.7	7.18	0.04				
9	Stevenson Lane	1'	7.18	0.68	20.91	0.13	23	6614	6614	644
		1'	7.34	0.73	24.67	0.16				
		4'	7.35	0.73	22.99	0.15				
10	Wheybridge Drive	1'	7.12	0.69	1.73	0.01	2	8945	8945	864
		1'	7.13	0.69	2.2	0.01				
		4'	7.12	0.69	2.98	0.02				
11	Cawood Drive	1'	7.18	0.71	3.14	0.02	3	10525	10525	903
		1'	7.19	0.71	1.82	0.01				
		4'	7.18	0.71	3.91	0.03				
12	Letchworth Drive	1'	7.19	0.72	1.09	0.01	3	9370	9370	882
		1'	7.21	0.72	2.37	0.02				
		4'	7.18	0.71	5.63	0.04				
13	Southport Lane	1'	7.21	0.72	16.36	0.11	15	8949	8949	863
		1'	7.25	0.74	15.81	0.11				
		4'	7.25	0.74	14.2	0.1				
14	Bolton Lane	1'	7.16	0.7	19.44	0.13	18	7581	7581	706
		1'	7.17	0.71	19.6	0.13				
		4'	7.11	0.68	15.38	0.1				
15*	North Rillington Drive	1'	9.48	0.89	6.87	0.06	7	8948	8948	822
		1'	9.44	0.88	7.44	0.06				
		4'	9.46	0.88	7.15	0.06				
16*	South Rillington Drive	1'	9.45	0.87	2.84	0.02	4	10501	10501	807
		1'	9.46	0.88	4.45	0.04				
		4'	9.45	0.88	3.65	0.03				
17	Chelmsworth Circle	1'	7.04	0.65	30.8	0.19	31	6349	6349	794
		1'	7.09	0.65	30.54	0.19				
		4'	7.09	0.65	32.12	0.2				
18**	Cooper Road	-	-	-	-	-	26	-	-	-
		-	-	-	-	-				
		-	-	-	-	-				
19	Camden Road #1	1'	7.24	0.73	6.04	0.04	4	10330.78	10331	969.92
		1'	7.2	0.72	2.28	0.01				
		4'	7.23	0.73	4.3	0.03				
20	Camden Road #2	1'	7.23	0.73	3.75	0.02	3	9311.872	9312	909.07
		1'	7.22	0.72	2.38	0.02				
		4'	7.19	0.71	2.28	0.01				
21	Midenhall Drive	1'	7.42	0.78	9.15	0.06	8	8951.971	8952	827
		1'	7.40	0.78	8.14	0.06				
		4'	7.37	0.77	7.87	0.05				
22	Glemsford Drive	1'	7.33	0.75	8.75	0.06	5	10740.67	-	856.14
		1'	7.35	0.76	3.78	0.03				
		4'	7.38	0.77	2.51	0.02				
23	Kinross Drive	-	7.40	0.75	8.37	0.06	9	10213.15	10213	968.4
		-	-	-	-	-				
		-	-	-	-	-				

*Sampled pipe has a nominal 8" diameter **Cooper Road Sample 18 is from a live tap coupon ¹Fitting failure prior to pipe bursting

5.3.3 Conclusion

Visual inspection did not identify any obvious anomalies on all pipes sampled. While degradation was not obvious through visual inspection, phenolphthalein staining demonstrated high variability (a difference of 30% between minimum and maximum values) for AC pipe degradation across the BVVPOA water system. There was no internal degradation, suggesting that the conveyed water is non-aggressive to AC pipe. Hardness test showed that phenolphthalein staining was a conservative method of measuring the level of degradation, since the entire degraded portion identified by phenolphthalein staining has not lost enough strength/hardness to be considered soft AC. Data from destructive testing methods such as crushing and hydrostatic testing shows that all sampled AC locations perform better than AWWA standards. The results from rupture modulus and tensile strength plots (Figure 5-11 and Figure 5-16) correlate very well with each other. The 32% degradation value can be taken to be the point where out of 100 tested samples 95 of them will perform better than AWWA standards. Therefore, 32% degradation can be considered to be the degradation level that it is not desired for pipes in service to exceed. With this knowledge, utilities can continue to monitor AC pipe and assess the need for rehabilitation based solely on the extent of degradation without destructive testing. This process is further discussed in the Remaining service life chapter.

6 Rate of AC Pipe Degradation

6.1 Introduction

From the previous chapter, the current level of degradation of samples obtained from BVVPOA was identified. Given these results, the threshold degradation level at which the AC pipes fail to meet AWWA specifications for crushing strength and hydrostatic strength was determined. The next piece of information required to assess the remaining service life of AC pipe in the BVVPOA system is understanding the rate at which degradation occurs in AC pipe. Since the rate of degradation is very dependent on the environmental conditions in which the pipe is buried, it is very difficult to determine an absolute rate of degradation. However, the shape (i.e., linear, logarithmic, or exponential) of the curve that describes AC pipe degradation versus time can be determined. This chapter presents the results of three phases of acid experiments that provide a better understanding of the rate of degradation plot for AC pipe.

6.2 Results from Phase I, II and III of Acid Testing

Phase I

Phase I of testing addresses the shape of the rate of degradation plot for samples at different levels of initial degradation (degradation at time of insertion into the acid bath). There were two groups of samples placed in 1:10 diluted Nitric acid solution in addition to the control group placed in water. The first group had 1-2% initial degradation and the second group had 24-25% initial degradation. In Figure 6-1, the change in degradation versus time are shown for the two groups of samples. The change in degradation (initial degradation minus final degradation) is plotted on the primary y axis (left) and the pH of the solution is plotted on the secondary y axis (right). The accuracy of the pH probe below pH of 1 cannot be verified; therefore attention

should be given to only the trend of increasing pH and not the absolute pH values. It should also be noted that the plot only consists of data up to 60 days since the level of acid dropped below the sample, forcing the test to be stopped.

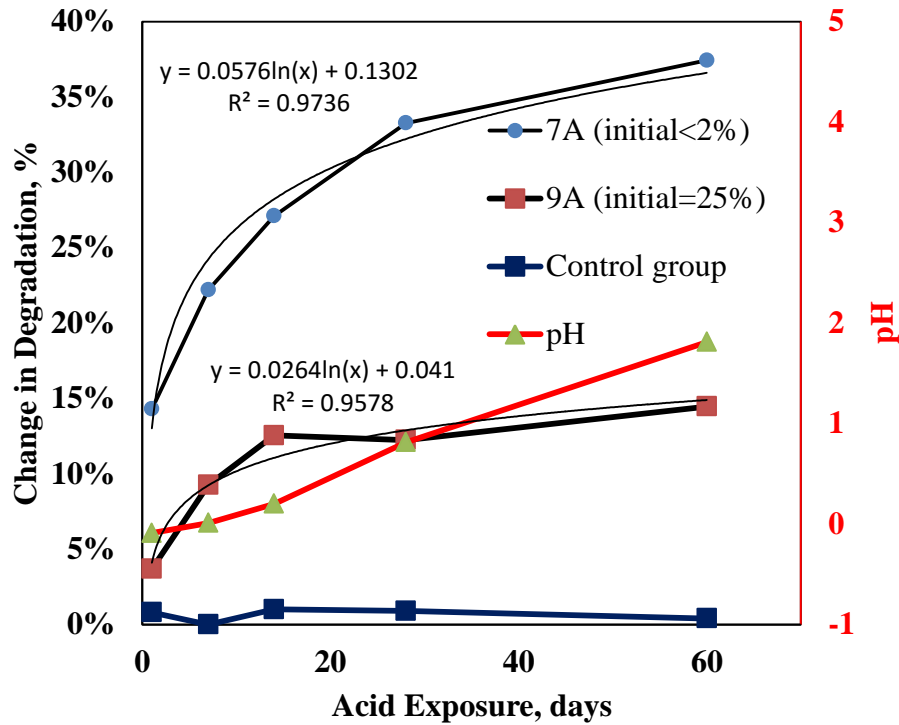

Figure 6-1. Rate of degradation from Phase I acid testing

It is observed from Figure 6-1 that samples with initial degradation <2% produced about 20% higher change in degradation than those samples that started at 25% degradation. This is because the acid solution has to advance through the initially degraded portion of the sample before causing further degradation. An example for samples pulled at 7 days is shown in Figure 6-2 for a clearer understanding of the difference in degradation between the two groups of samples. The sample with initial degradation of 1-2% had an approximately 29% change in degradation in 7 days while the sample with initial degradation of 24-25% had an approximately 10% change in degradation in the same time span. The acid begins causing degradation on

samples with <2% degradation almost immediately while the pH is still very low. It is also observed from Figure 6-1 that the pH of the solution increases with time, therefore the change in degradation for the 25% sample is not as appreciable as the sample with <2% degradation. This is because when the acid reaches the undegraded portion of group 2 (24-25% degradation), it has lost some of its degrading capability.

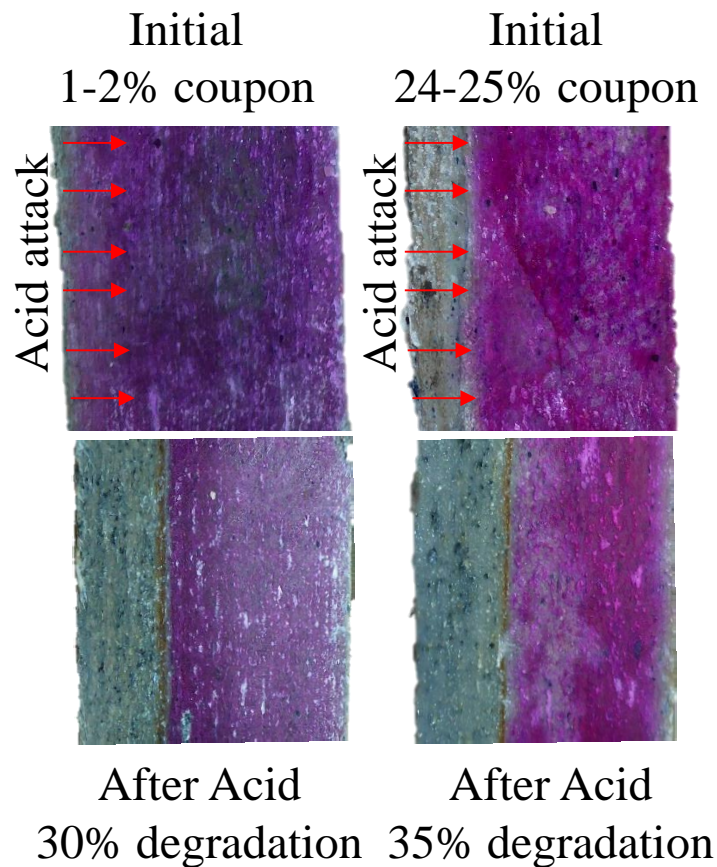

Figure 6-2. Change in degradation at 7 days shown for Phase I samples

The samples degraded in a decreasing logarithmic trend with a coefficient of confidence greater than 0.95 for both. This data could wrongly be interpreted as suggesting that the outside degraded portion of the AC pipe shields the internal portion of the pipe as suggested by Stark and Charlton (2008). However, closer analysis of the solution pH suggests that the acid gradually

loses its degrading capability as the free hydrogen atoms are reacting with the sample. Therefore, this decreasing trend is most likely attributable to the loss of degrading capability of the acid rather than the outer AC material shielding the inner portion.

Phase II

The second phase of accelerated acid testing addressed the issue of using high concentration acid to model the attack that occurs under low concentration and strength acid in the ground. The data from Phase II is presented in Figure 6-3, which plots the calcium and magnesium concentrations as a function of number of days the coupon has been exposed to acid. Magnesium was measured along with calcium since calcium proved difficult to measure for dilutions higher than 1:100. The higher dilutions were not capable of leaching out measurable amounts of Calcium. The level of calcium measured was on the same range as the control group which was conducted using tap water. It is expected that the background Ca in the tap water caused errors in measurement at the small concentrations of Ca produced by the 1:1,000 and 1:10,000 dilutions.

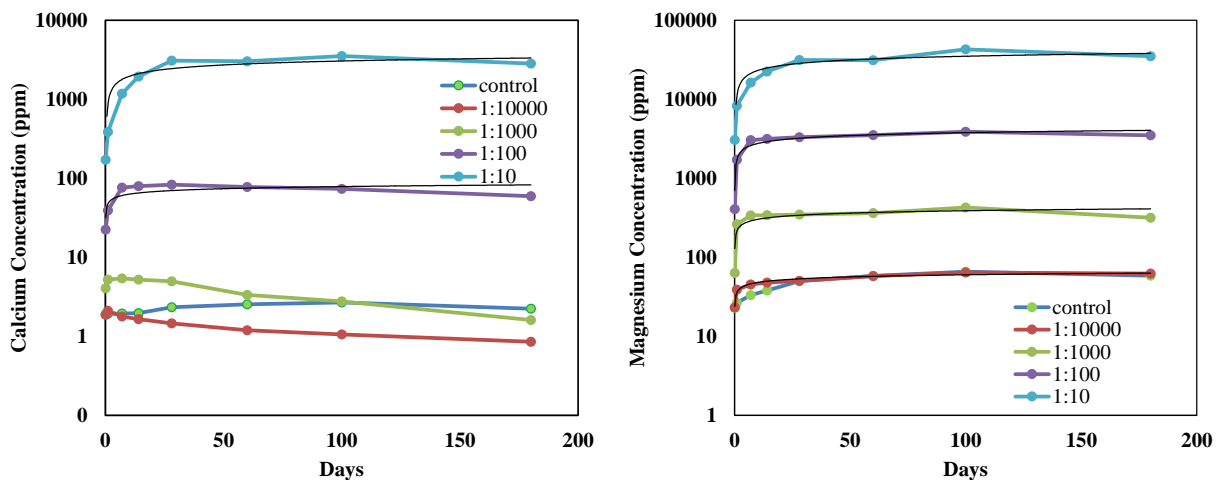

Figure 6-3. Cation measurement to determine level of degradation for Phase II of acid test

It can be observed from this figure that the concentration of acid in the solution can be seen to affect how much calcium or magnesium is leached out of the AC specimen but does not influence the trend at which the leaching is occurring (the shape of the rate of degradation curve). This suggests that the acid testing conducted at higher pH acids than would naturally occur in-situ is an acceptable method. If higher concentration acids degrade AC pipe faster than low concentration acids but the shape of degradation is similar, then the shape of the rate of degradation curve from strong acid testing can be used to model what happens in soils which have relatively weak strength acids. It should also be noted that the decreasing trend could be a function of the rise in pH of the solution as was seen from Phase I. For this reason results from Phase III of acid testing are highly crucial.

Phase III

By keeping the acid concentration consistent on a weekly basis, a better understanding of the shape of the rate of degradation curve can be achieved. The level of Calcium and Magnesium ions leached out during exposure to the different strength acids was measured and is presented in Figure 6-4. A constant amount of calcium and magnesium was leached out over the duration of the 63 day period. The 1:5 and 1:10 diluted solution produced negative values for Magnesium measurements. The reason for this bad data is unclear; however, there could be Magnesium precipitate that formed causing the levels to drop. The 1:10,000 and 1:1,000 diluted samples were too weak to leach Calcium out that was measurably comparable with other data as seen in Figure 6-3 from Phase II. For these reasons those values are not available in the Phase III plots.

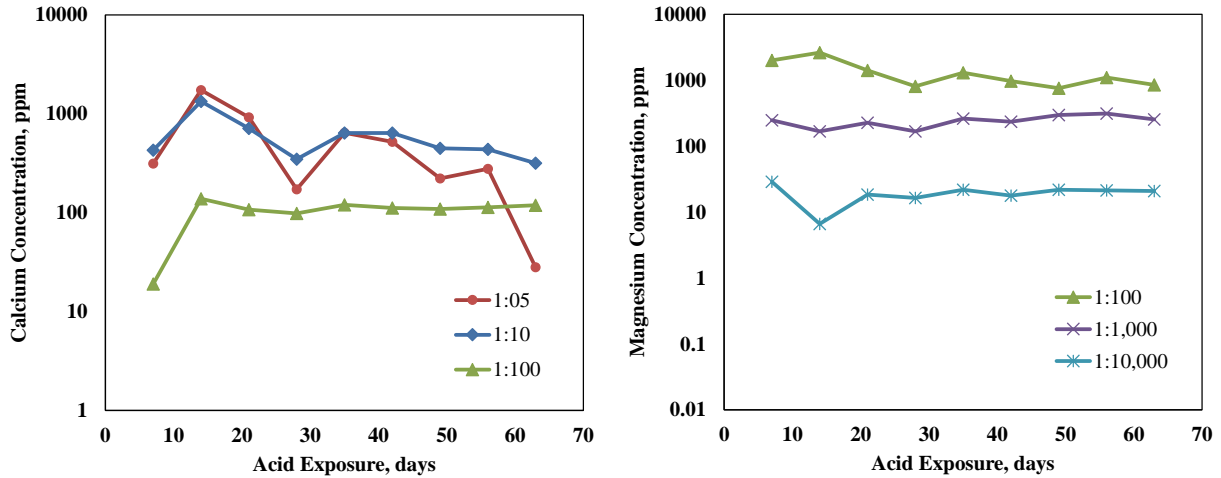

Figure 6-4. Phase III Calcium and Magnesium ion levels

The calcium plot has some non-linearity at the beginning and end of the testing program. The initial increase (up to 14 days) could be from the saturation period for the coupon while the acid is readily leaching out ions from the portions of the thickness closest to the surface. After this two week period, the acid progresses at a linear rate by leaching out constant levels of calcium. This suggests that once the acid has progressed through the top surface of the coupon, the amount of Ca and Mg leached out through time becomes constant. There is a sharp decline observed in the 1:05 acid dilution for Calcium at 56 days, which is a result of full degradation being achieved by the coupon. The data from the Calcium and Magnesium plots provides a comprehensive understanding about the shape of the rate of degradation for AC pipe at different acid strengths. To better understand Figure 6-4, the amount of Calcium and Magnesium ion leached at each time interval was correlated to the level of degradation achieved by the sample. Coupon samples were pulled at interval times that allowed for measurement of degradation, while also sampling 15ml solution for calcium and magnesium level measurements. This allowed for an estimation of how much calcium and magnesium was being leached out for each 1% increase in degradation as presented in Table 6-1. The total amount of calcium or magnesium

in the solution at time of testing was divided by the amount of degradation (phenolphthalein % degradation) to give an estimate of the amount of calcium and magnesium ions being leached per 1% degradation.

Table 6-1. Correlation between leached calcium and magnesium to increase in degradation

Acid dilution	Calcium ppm/1% degradation	Magnesium ppm/1% degradation
1:5	52.0607519	-
1:10	56.1918724	-
1:100	58.0581038	734.1763019
1:1,000	-	734.1763019
1:10,000	-	734.1763019

Using Table 6-1, a plot presented in Figure 6-5 can be developed, which is a better depiction of the shape of the rate of degradation since it provides a relationship between degradation and duration of acid exposure. There is a linear relationship observed between degradation and time of exposure which suggests that the outside degraded portion of AC pipe does not protect the inner portion of the pipe.

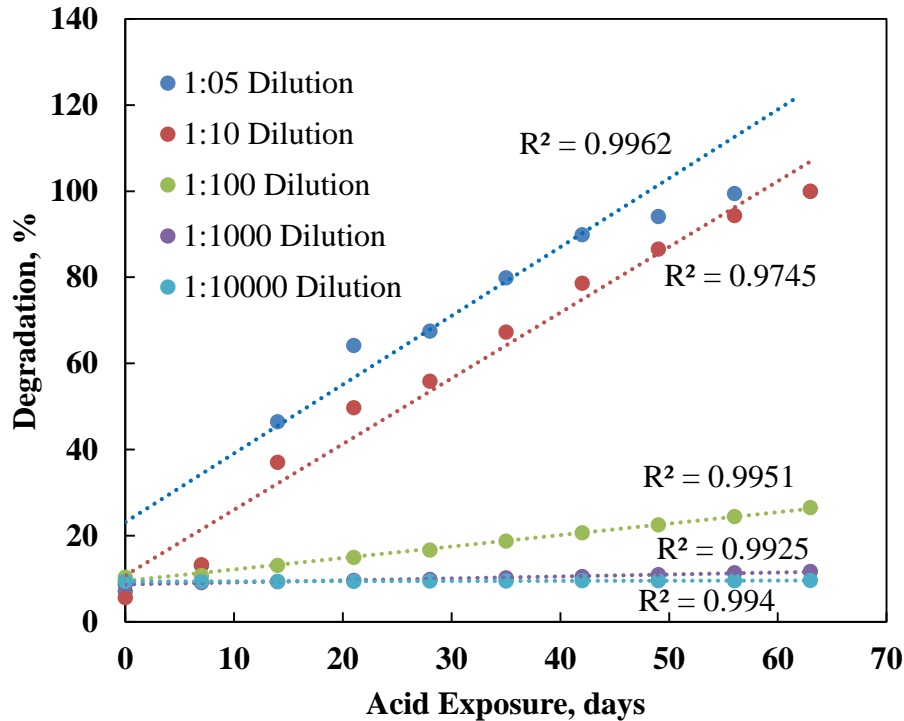

Figure 6-5. Phase III acid test results showing linear rate of degradation for all dilutions

The data from both calcium and magnesium was used to create this plot which provides data for acid dilution ranges from 1:5 to 1:10,000. All dilutions result in a linear trend line with coefficient of determination greater than 0.97. The high coefficient of determination suggests that for samples exposed to constant strength aggressive environment, AC pipe will continue to degrade at a linear rate until full degradation is achieved. This approach is considered conservative since, the likelihood of an AC pipe being exposed to an environment that does not lose its aggressivity throughout its lifetime is highly unlikely if not impossible. AC pipe buried under aggressive water is probably the only case that could resemble this worst case scenario. Therefore, a linear rate of degradation can be assumed to occur in AC pipes buried under ground and a conservative remaining service life can be calculated accordingly.

6.3 Conclusion

The results from Phase III of the acid testing suggest that the non-linear trends from Phase I and II of the accelerated acid testing program were a function of the acid losing its degrading capability from titrating effect caused by the CaCO_3 from the AC pipe. Phase III testing showed that the degraded portion does not shield the inner portion of the AC pipe once the acid has penetrated through the surface. The degradation front will continue to progress linearly with time through the thickness of the pipe wall. However, for this to occur, there has to be a constant supply of degrading elements acting at a constant strength. Since this scenario is unlikely for buried pipes, the linear degradation rate is assumed to be a conservative estimate for acquiring remaining service life.

7 Future Life Prediction for AC Pressure Pipes

7.1 Introduction

With a threshold degradation value of 32% determined from the crushing and hydrostatic test results and a linear rate of degradation determined from the accelerated acid experiments, the remaining service life of AC pipe can be estimated. This chapter discusses the results from remaining service life analysis and provides a timeline for BVVPOA to direct more attention to specific locations within the water system.

7.2 Remaining service life using a linear degradation relationship

The amount of degradation per year can be calculated by dividing the current level of degradation by the number of years the pipe has been in service. This provides an estimate of the degradation amount that has occurred annually and is presented in Table 7-1. Since the soil environment surrounding each pipe is different, the rate determined is specific only to that sample of pipe. This degradation rate described in inches/year can be plotted in a bar graph as presented in Figure 7-1. 48% of the samples from BVVPOA have degradation rates between .001-.003 inches/year while, the maximum rates are from Chelmsworth Circle (Sample 17) with 0.0047 inches/year and Allonby Circle (Sample 3) with 0.0033 inches/year. Assuming the maximum rate of degradation of 0.0047 inches/year, it would require 149 years to fully degrade an AC pipe of 0.7 inches thickness at Chelmsworth Circle. This suggests that the soil in BVVPOA is only moderately aggressive to AC pipe as was observed from previous phenolphthalein, crushing, and hydrostatic test results.

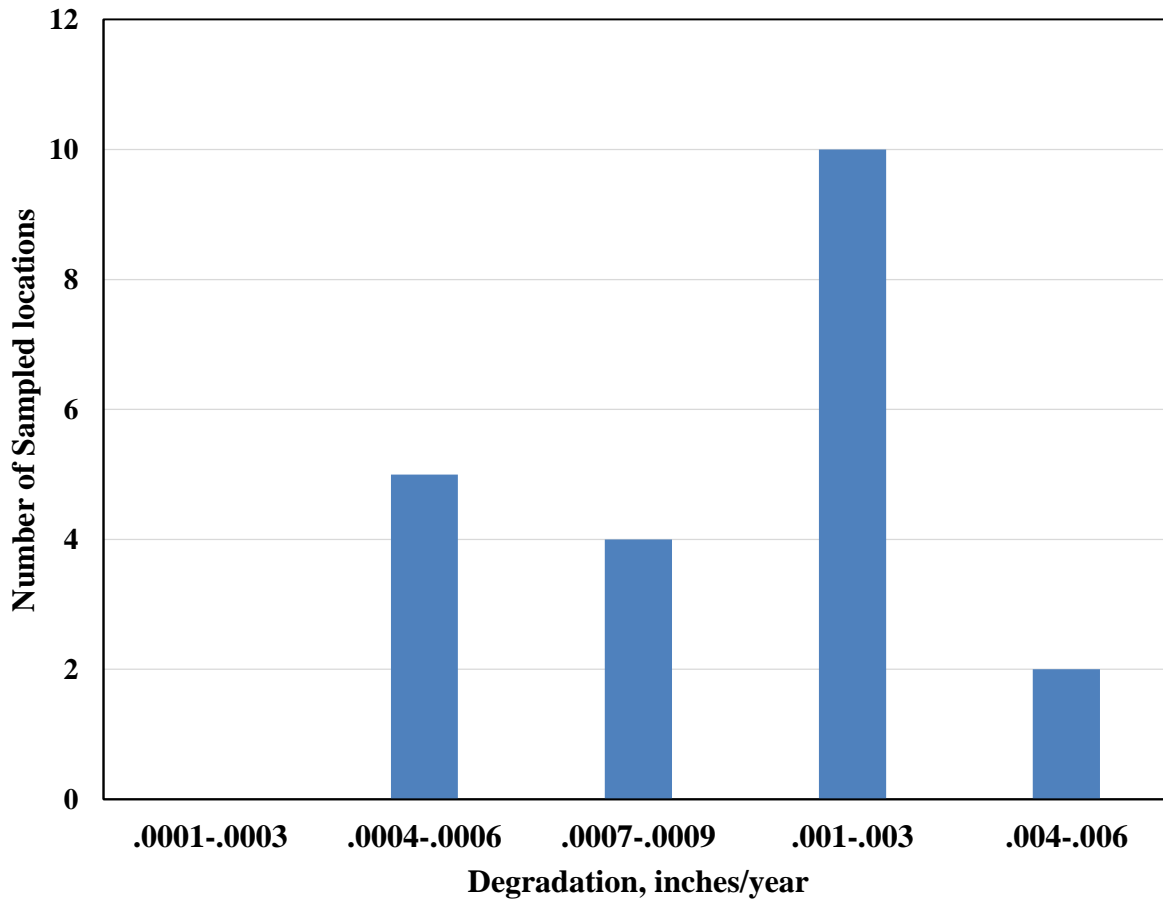

Figure 7-1. Degradation rate, inches/year for samples from BVVPOA

The remaining service life was calculated for each sampled location by linearly extrapolating the rate of degradation vs time plot into the future as presented in Figure 7-2 for samples 9 and 17 from Stevenson Drive and Chelmsworth circle, respectively. The linear extrapolation was carried out to determine the year at which the degradation would reach a value of 32%, which was determined to be the threshold value using AWWA requirements. This method is location dependent since the slope of the extrapolated line depends on the level of degradation experienced by the sample during service.

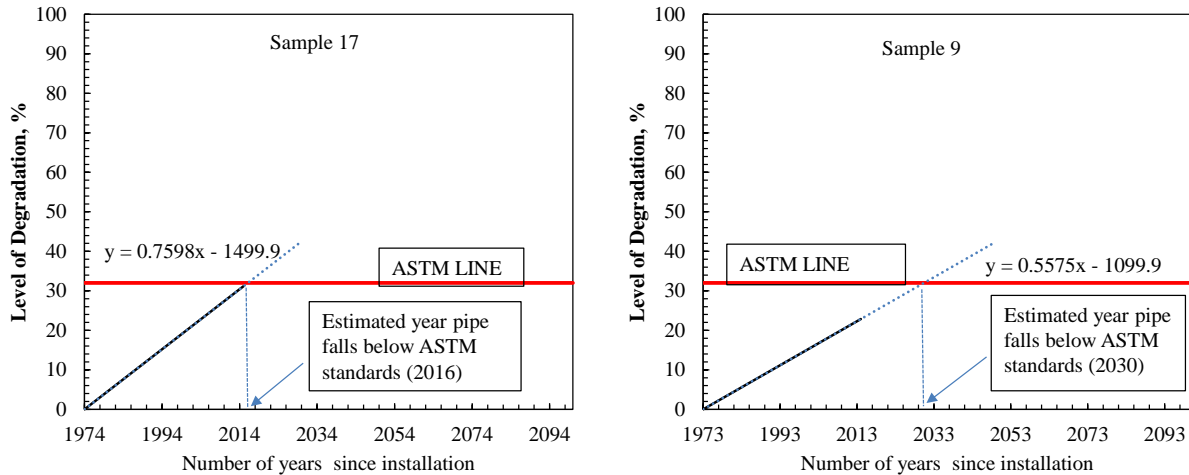

Figure 7-2. Degradation vs Time plot for remaining service life calculation

The difference in slopes can be seen between Sample 9 and 17. Sample 9 has a slope of 0.5575 which suggests that the sample is degrading at a slower rate than Sample 17 which has a slope of 0.7598. Sample 9 is expected to fall below AWWA standards in the year 2030 while Sample 17 is expected to fall below AWWA standards in the year 2016.

The data for all the sampled locations is summarized and presented in Table 7-1. Sample 17 from Chelmsworth Circle can be noted as requiring the soonest attention while most sampled locations have remaining service lives of greater than 100 years as depicted in Figure 7-3. Sample 18 from Cooper Road and Sample 9 from Stevenson Lane, Sample 3 from Allonby Circle along with Sample 17 from Chelmsworth Circle require attention within the next 20 years.

Table 7-1. Tabulated results of remaining service life

Sample	Location	Degradation, %	Degradation, inches/year	Year Installed	Years Sampled	Service Life	Remaining Service Life
1	Windermere Lane	12	0.0019	1973	2014	41	72
2	Gainford Drive	13	0.0020	1973	2014	41	61
3	Allonby Circle	21	0.0033	1973	2014	41	20
4	Hexham Drive	8	0.0012	1976	2014	38	>100
5	SunSet Drive	1	-	-	2014	-	-
6	Churchill Drive	18	0.0029	1973	2014	41	33
7	Wheybridge and Haslemere Ln.	3	0.0005	1973	2014	41	>100
8	Orchid Tree Lane	5	0.0007	1981	2014	33	>100
9	Stevenson Lane	23	0.0030	1973	2014	41	16
10	Wheybridge Drive	2	0.0004	1973	2014	41	>100
11	Cawood Drive	3	0.0005	1973	2014	41	>100
12	Letchworth Drive	3	0.0005	1974	2014	40	>100
13	Southport Lane	15	0.0025	1973	2015	42	45
14	Bolton Lane	18	0.0028	1974	2015	41	31
15	North Rillington Drive	7	0.0014	1974	2015	41	>100
16	South Rillington Drive	4	0.0007	1974	2015	41	>100
17	Chelmsworth Circle	31	0.0047	1974	2015	41	1
18	Cooper Road	26	-	1970	2015	45	10
19	Camden Road #1	4	0.0006	1970	2015	45	>100
20	Camden Road #2	3	0.0004	1970	2015	45	>100
21	Midenhall Drive	8	0.0014	1973	2015	42	>100
22	Glemsford Drive	5	0.0008	1973	2015	42	>100
	Kinross Drive	9	0.0019	1981	2015	34	87

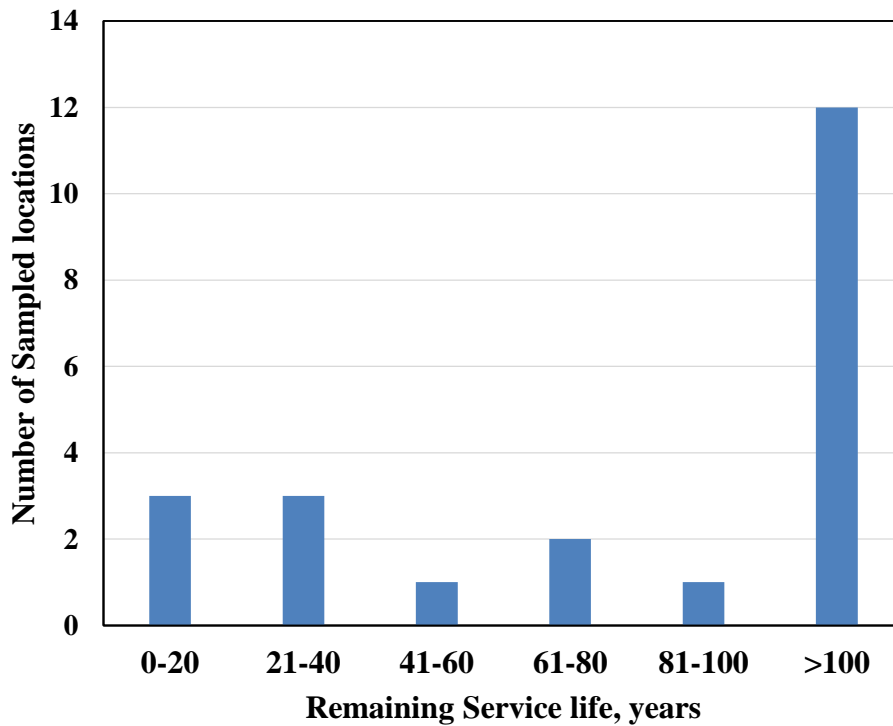

Figure 7-3. Bar graph depicting the distribution of remaining service life across the utility

From Figure 7-3 above it can be observed that 54% of the sampled locations have more than 100 years of remaining service life. Only Seven locations require attention within the next

60 years which are Cooper Road (18): remaining life of 10 years, Chelmsworth Circle (17): remaining life of 1 years, Bolton Lane (14): remaining life of 31 years, Stevenson Lane (9): remaining life of 16 years, Churchill Drive (6): remaining life of 33 years, Allonby Circle (3): remaining life of 20 years, and Southport Lane (13): remaining life of 45 years.

It is also interesting to look at the remaining service life for these pipes, if other controlling measures are taken into account. When considering less stringent requirements such as 2/3 AWWA requirements or 2*Class 150 pressure requirement, the remaining service life increases dramatically as presented in Table 7-2.

Table 7-2. Remaining service life considering various controlling scenarios

Sample	Location	Remaining Service Life				
		AWWA	2/3 *AWWA	1/3 *AWWA	3*Class 150	2*Class 150
1	Windermere Lane	72	>100	>100	>100	>100
2	Gainford Drive	61	>100	>100	>100	>100
3	Allonby Circle	20	81	>100	62	100
4	Hexham Drive	>100	>100	>100	>100	>100
5	SunSet Drive	-	-	-	-	-
6	Churchill Drive	33	>100	>100	84	>100
7	Wheybridge and Haslemere Ln.	>100	>100	>100	>100	>100
8	Orchid Tree Lane	>100	>100	>100	>100	>100
9	Stevenson Lane	16	74	>100	56	92
10	Wheybridge Drive	>100	>100	>100	>100	>100
11	Cawood Drive	>100	>100	>100	>100	>100
12	Letchworth Drive	>100	>100	>100	>100	>100
13	Southport Lane	45	>100	>100	>100	>100
14	Bolton Lane	31	>100	>100	81	>100
15	North Rillington Drive	>100	>100	>100	>100	>100
16	South Rillington Drive	>100	>100	>100	>100	>100
17	Chelmsworth Circle	1	43	85	30	56
18	Cooper Road	10	65	>100	48	83
19	Camden Road #1	>100	>100	>100	>100	>100
20	Camden Road #2	>100	>100	>100	>100	>100
21	Midenhall Drive	>100	>100	>100	>100	>100
22	Glemsford Drive	>100	>100	>100	>100	>100
	Kinross Drive	87	>100	>100	>100	>100

Sample 17 from Chelmsworth Circle is predicted to fall below AWWA requirements in the coming year. However, when considering 2/3 of the AWWA requirements the remaining service life increases to 43 years, which is a large difference when considering how much difference this results for utilities concerned about when to budget for a replacement. Therefore, it is important to remember that AWWA requirements provide for a conservative approach into estimating remaining service life. To get a more accurate estimate, further research is required into the controlling failure mode, and individual site study has to be conducted for the AC pipes in the utility.

7.3 Conclusion

A linear rate of degradation with a 95th percentile prediction for AWWA requirements is considered a conservative approach towards estimating the remaining service life. The majority (54%) of tested AC pipes from BVVPOA have remaining service life of greater than 100 years. Chelmsworth Circle (Sample 17), Cooper Road (Sample 18), and Stevenson Lane (Sample 9) require the soonest attention. This remaining service life estimate is a conservative approach since it uses the 95th percentile line intersection with AWWA requirement. Pipes perform without problem at strength levels below AWWA requirements; however, due to the variability and limitation of data available, AWWA was considered to be an appropriate threshold limit.

8 Conclusion

Asbestos cement pipes collected from BVVPOA were tested to determine extent of degradation, residual strength, and remaining service life. BVVPOA delivered two one foot long and one four foot long section of pipe for each of the 23 sampling locations in the study. Testing methods for determining extent of degradation included visual observation, phenolphthalein staining, and hardness testing. Residual strength was measured using destructive testing methods particularly crushing and hydrostatic testing. Information from accelerated acid testing was used to determine the remaining service life.

Visual observation and initial measurements were used to identify the cross-sectional properties of the AC pipes including outside diameter and thickness. The outside diameters ranged from 7.04-7.42 inches for the 6 inch samples, 9.44-9.55 inches for the 8 inch samples and the thickness ranged from 0.65-0.78 inches for the 6 inch samples, and 0.87-0.90 inches for the 8 inch samples. Given this variation, additional calculations were performed to compare the crushing and hydrostatic test results between the different pipe samples. Phenolphthalein staining was performed on pipes from all sampled locations. The surfaces of the pipes were ground to expose a fresh surface for phenolphthalein staining. Degraded portions of AC pipe do not react with phenolphthalein, leaving the grayish AC pipe color. The free lime from the non-degraded portions of AC pipe reacts with the phenolphthalein solution producing a purple discoloration. A digital caliper is then used to measure the extent of degradation as a function of the thickness. The hardness test was used to check results from phenolphthalein staining. A Shore D Durometer was used to measure the hardness across the cross-section of the AC pipe. The test was performed at 8 locations between the outside face of the pipe and the inside face of the pipe. While degradation was not obvious through visual inspection, phenolphthalein staining

demonstrated a high variability of AC pipe degradation across the BVVPOA water distribution system with degradation values ranging from 1%-31% with the majority of pipes (61%) having less than 10% degradation. For all samples collected from BVVPOA only external degradation was observed suggesting that the conveyed water in BVVPOA is non-aggressive to AC pipe. From the hardness test results, phenolphthalein staining was determined to be conservative method of estimating the level of degradation, since the entire degraded portion identified by phenolphthalein staining is not soft AC.

For the one foot long sections of pipe provided by BVVPOA, crushing testing was performed to acquire the residual transverse strength of the AC pipes. Testing was conducted according to AWWA C400-03. The load path was recorded during testing and the failure load was considered the residual crushing strength for that sample. From the crushing test results, it was determined that all pipe samples had crushing strengths higher than values required by AWWA C400-03 specifications with crushing failure loads ranging from 11,600 lb/ft for samples near 0% degradation to 6349 lb/ft for Chelmsworth circle with 31 % degradation.

Hydrostatic pressure testing was conducted on the four foot sections provided by BVVPOA. The ends of the pipe were sealed with cast iron end caps and a hand pump was used to increase the internal water pressure until failure. The failure pressure was recorded as the residual hydrostatic strength for the tested sample. From the hydrostatic test results, it was determined that all pipe samples had hydrostatic failure pressures higher than values required by AWWA specifications with failure pressures ranging from 972 psi for samples with no measurable degradation to 644 psi for Stevenson Lane with 23 % degradation.

By comparing the measured degradation determined by phenolphthalein staining and the crushing and hydrostatic failure, the level of degradation that corresponds to 95% of the AC pipe

samples failure above that level was determined to be 32%. This value corresponds to a conservative point where AC pipe no longer has the strength, according to AWWA specifications, to perform its intended function (i.e., convey drinking water without failing due to internal or external loads). Although this is the point where the AC pipe no longer meets AWWA specifications, this does not mean that the AC pipe is approaching a hydrostatic or crushing type failure in the field. Significant life may remain for pipe which fall below this point. However, this is the point when pipes should be monitored more closely to ensure they are meeting performance expectations and planning for future replacement should begin. A complete summary of the data determined for each AC pipe sample is provided in Table 8-1.

After information was gathered on the extent of degradation and residual strength, accelerated acid testing was performed to determine the rate of AC pipe degradation for samples in the BVVPOA. Small 3" by 3" AC specimen were cut from a one foot long section of AC pipe for acid testing. The acid testing included three phases where different acid strengths were used to determine the rate of degradation. The 3" by 3" samples were immersed in an acid bath for different lengths of exposure. The extent of degradation was measured by Ca and Mg ion measurements and when possible phenolphthalein staining. It was determined that the rate of AC pipe degradation is linear with time (i.e., the degradation from 0-10% occurs over the same time length as 90-100%). Therefore, when estimating the remaining service life of AC pipes one can simply linearly extrapolate the rate of degradation determined over the service life of the pipe (i.e., measured degradation divided by years of service) to determine the future degradation of the AC pipe.

Since pipe samples from BVVPOA only had slight to moderate degradation levels (i.e., <35%), acid was used to artificially degrade both one foot long and four foot long AC pipe

samples. These samples were sealed with either Plasti-dip (one foot samples) or Fernco caps (four foot samples) to prevent internal degradation. Samples were exposed to a solution of 10% Nitric acid and allowed degrade for varying lengths of time. This produced full scale AC pipe samples with levels of degradation varying 10 to 85% degradation. Accelerated acid samples with less than 30% degradation were determined to have similar (within 15%) of naturally degraded samples indicating that artificially degrading the AC pipe samples is an appropriate method for providing additional AC pipe specimen at high levels of degradation.

After determining the critical degradation amount of 32% and determining the current level of degradation of each AC pipe sample taken from BVVPOA, the remaining service life of each sample was estimated. These estimates are summarized in Table 8-2. For the majority (54%) of AC pipe samples provided by BVVPOA, a remaining service life of greater than 100 years was estimated. However, some locations particularly Chelmsworth Circle (Sample 17) with 31% degradation and a remaining service life of approximately 1 year should be monitored closely in the coming years.

Table 8-1. Summary of results from tested locations

Sample No.	Street Address	Type of Sample	Outside diameter (in)	Thickness (in)	Percent Degraded	Degraded Thickness (in)	Average Degradation %	Crushing Load (lb/ft)	Average Crushing Load (lb/ft)	Hydrostatic Pressure (psi)
1	Windermere Lane	1'	7.33	0.74	15.21	0.11	11.6	10185	10002	920
		1'	7.32	0.76	11.4	0.08		9820		
		4'	7.33	0.73	8.18	0.05				
2	Gainford Drive	1'	7.15	0.69	15.46	0.1	12.92	10288	9865	923
		1'	7.12	0.68	13.35	0.08		9442		
		4'	7.09	0.68	9.97	0.06				
3	Allonby Circle	1'	7.13	0.7	21.8	0.14	21.46	8642	8604	862
		1'	7.12	0.69	22.09	0.14		8567		
		4'	7.17	0.71	20.49	0.13				
4	Hexham Drive	1'	7.15	0.68	9.65	0.06	7.57	10563	10563	905
		1'	7.13	0.7	7.59	0.05				
		4'	7.14	0.68	5.46	0.03				
5* ¹	SunSet Drive	1'	9.55	0.89	0.41	0	0.88	11606	11606	
		1'	9.54	0.89	0.76	0.01				
		4'	9.55	0.9	1.48	0.01				
6	Churchill Drive	1'	7.18	0.71	12.05	0.08	17.77	9086	9086	826
		1'	7.22	0.72	21.02	0.15				
		4'	7.23	0.7	20.23	0.13				
7	Wheybridge and Haslemere Ln.	1'	7.17	0.72	4.71	0.03	3.39	9844	9844	785
		1'	7.12	0.69	2.27	0.01				
		4'	7.09	0.67	3.18	0.02				
8	Orchid Tree Lane	1'	7.18	0.71	5	0.01	5.07	9208	9208	972
		1'	7.16	0.7	3.03	0.02				
		4'	7.18	0.7	7.18	0.04				
9	Stevenson Lane	1'	7.18	0.68	20.91	0.13	22.86	6614	6614	644
		1'	7.34	0.73	24.67	0.16				
		4'	7.35	0.73	22.99	0.15				
10	Wheybridge Drive	1'	7.12	0.69	1.73	0.01	2.3	8945	8945	864
		1'	7.13	0.69	2.2	0.01				
		4'	7.12	0.69	2.98	0.02				
11	Cawood Drive	1'	7.18	0.71	3.14	0.02	2.96	10525	10525	903
		1'	7.19	0.71	1.82	0.01				
		4'	7.18	0.71	3.91	0.03				
12	Letchworth Drive	1'	7.19	0.72	1.09	0.01	3.03	9370	9370	882
		1'	7.21	0.72	2.37	0.02				
		4'	7.18	0.71	5.63	0.04				
13	Southport Lane	1'	7.21	0.72	16.36	0.11	15.46	8949	8949	863
		1'	7.25	0.74	15.81	0.11				
		4'	7.25	0.74	14.2	0.1				
14	Bolton Lane	1'	7.16	0.7	19.44	0.13	18.14	7581	7581	706
		1'	7.17	0.71	19.6	0.13				
		4'	7.11	0.68	15.38	0.1				
15*	North Rillington Drive	1'	9.48	0.89	6.87	0.06	7.15	8948	8948	822
		1'	9.44	0.88	7.44	0.06				
		4'	9.46	0.88	7.15	0.06				
16*	South Rillington Drive	1'	9.45	0.87	2.84	0.02	3.65	10501	10501	807
		1'	9.46	0.88	4.45	0.04				
		4'	9.45	0.88	3.65	0.03				
17	Chelmsworth Circle	1'	7.04	0.65	30.8	0.19	31.15	6349	6349	794
		1'	7.09	0.65	30.54	0.19				
		4'	7.09	0.65	32.12	0.2				
18**	Cooper Road	-	-	-	-	-	26.11	-	-	-
		-	-	-	-	-		-	-	-
		-	-	-	-	-		-	-	-
19	Camden Road #1	1'	7.24	0.73	6.04	0.04	4.21	10330.78	10331	969.92
		1'	7.2	0.72	2.28	0.01				
		4'	7.23	0.73	4.3	0.03				
20	Camden Road #2	1'	7.23	0.73	3.75	0.02	2.8	9311.872	9312	-
		1'	7.22	0.72	2.38	0.02				
		4'	7.19	0.71	2.28	0.01				
21	Midenhall Drive	1'	7.42	0.78	9.15	0.06	8.39	8951.971	8952	827
		1'	7.40	0.78	8.14	0.06				
		4'	7.37	0.77	7.87	0.05				
22	Glemsford Drive	1'	7.33	0.75	8.75	0.06	5.01	10740.67	-	-
		1'	7.35	0.76	3.78	0.03				
		4'	7.38	0.77	2.51	0.02				
23	Kinross Drive	-	7.40	0.75	8.37	0.06	9	10213.15	10213	968.4
		-	-	-	-	-				
		-	-	-	-	-				

*Sampled pipe has a nominal 8" diameter **Cooper Road Sample 18 is from a live tap coupon ¹Fitting failure prior to pipe bursting

Table 8-2. Remaining service life for sampled locations

Sample	Location	Degradation, %	Degradation, inches/year	Year Installed	Years Sampled	Service Life	Remaining Service Life
1	Windermere Lane	11.60	0.0019	1973	2014	41	72
2	Gainford Drive	12.92	0.0020	1973	2014	41	61
3	Allonby Circle	21.46	0.0033	1973	2014	41	20
4	Hexham Drive	7.57	0.0012	1976	2014	38	>100
5	SunSet Drive	0.88	-	-	2014	-	-
6	Churchill Drive	17.77	0.0029	1973	2014	41	33
7	Wheybridge and Haslemere Ln.	3.39	0.0005	1973	2014	41	>100
8	Orchid Tree Lane	5.07	0.0007	1981	2014	33	>100
9	Stevenson Lane	22.86	0.0030	1973	2014	41	16
10	Wheybridge Drive	2.30	0.0004	1973	2014	41	>100
11	Cawood Drive	2.96	0.0005	1973	2014	41	>100
12	Letchworth Drive	3.03	0.0005	1974	2014	40	>100
13	Southport Lane	15.46	0.0025	1973	2015	42	45
14	Bolton Lane	18.14	0.0028	1974	2015	41	31
15	North Rillington Drive	7.15	0.0014	1974	2015	41	>100
16	South Rillington Drive	3.65	0.0007	1974	2015	41	>100
17	Chelmsworth Circle	31.15	0.0047	1974	2015	41	1
18	Cooper Road	26.11	-	1970	2015	45	10
19	Camden Road #1	4.21	0.0006	1970	2015	45	>100
20	Camden Road #2	2.80	0.0004	1970	2015	45	>100
21	Midenhall Drive	8.39	0.0014	1973	2015	42	>100
22	Glemsford Drive	5.01	0.0008	1973	2015	42	>100
	Kinross Drive	9.00	0.0019	1981	2015	34	87

9 Future Work

9.1 For Bella Vista Village Property Owner's Association

Soil samples have been collected from the sampling sites in BVVPOA. The cause to the different rates of degradation across Bella Vista can be investigated further and could allow for better life prediction. While the shape of the rate of degradation has been acquired through this research, there is still much work required in understanding the actual rate of degradation of buried AC pipe under in-situ conditions. Through continued testing of samples which are obtained from pipe breaks and/or system expansions, Table 5-1 and Table 7-1 can be expanded to include more pipe sections within the BVVPOA distribution system and provide a more comprehensive understanding of the AC pipe degradation level in the BVVPOA water distribution system.

9.2 General Asbestos Cement Pipe Research

There are several limitations to the research results provided in this report. One major limitation to the work is the correlation between degradation level and residual strength is based on an empirical correlation using measured field values. A more theoretically correct understanding of the relationship between degradation and residual strength could be determined based on the fracture properties of the degraded and undegraded portions of AC pipe. By understanding the fracture toughness of the degraded and undegraded portions of the AC pipe, the contribution of each section to the overall strength of the pipe can be determined. Therefore, the true residual strength of the AC pipe could be determined regardless of the amount of internal or external degradation measure for the pipe.

10 Works Cited

- ASTM (American Society for Testing and Materials). 2011. Standard Test Methods for Asbestos-cement Pipe. ASTM C500-11, Philadelphia, PA.
- AWWA. 2003a. Standard for Asbestos cement Distribution Pipe 4” through 16” for Water and other Liquids. AWWA C400-03, Denver, CO.: AWWA.
- Bracken, Marc, Dave Johnston, and Matthew Coleman. "Asset Management of Asbestos Cement Pipes using Acoustic Methods: Theory and Case Studies". Reston, VA: ASCE copyright Proceedings Of The Pipelines 2011 Conference, July 23-27, 2011, Seattle, Washington| d 20110000. American Society of Civil Engineers , 2011. Print.
- Canada Centre for Mineral and Energy Technology, B. NEBESAR, and GW RILEY. Asbestos/cement Pipe Corrosion-Part 1, Historical, Technological, Economic and Statistical Background., 1983. Print.
- Carde, Christophe, and Raoul François. "Effect of the Leaching of Calcium Hydroxide from Cement Paste on Mechanical and Physical Properties." Cement and Concrete Research 27.4 (1997): 539-50. Print.
- Chowdhury, Rudaba, Yafei Hu, and Dunling Wang. "Condition Evaluation of Asbestos Cement Water Mains". Pipelines 2012@ sInnovations in Design, Construction, Operations, and Maintenance, Doing More with Less. ASCE , 2012. 288-297. Print.
- Davis, Paul, et al. "Failure Prediction and Optimal Scheduling of Replacements in Asbestos Cement Water Pipes." Aqua-Journal of Water Supply 57.4 (2008): 239-52. Print.
- Denison, Irving A., and Melvin Romanoff. "Effect of Exposure to Soils on the Properties of Asbestos-Cement Pipe." Journal of Research of the National Bureau of Standards 47.5 (1951): 367. Print.
- E P White, “Usage and Performance of Asbestos Cement Pressure Pipe.” Water Research Center, 1985
- Fawell, John K. "Asbestos Cement Drinking Water Pipes and Possible Health Risks, Review for DWI." Devizes, Wiltshire: Drinking Water Inspectorate (2002)Print.
- Fisher, GC, and RM Morchat. Asbestos Characterization using Scanning Electron Microscopy/Light Element X-Ray Spectrometry (1993)Print.
- G Eric Williams, and Kent Von Aspern, “Asbestos Cement Pipe: What if it Needs to be Replaced?” HDR Engineering (2010)

- G. W. Stark, and R.S. Charlton. "Class 150 Asbestos Cement (AC) Watermain Pipe Condition Evaluation, Deep Bay Water District." Levelton Consultants Ltd. (2008)
- Harris, NJ, and M. Radlinski. "Asbestos-Cement Pipe Condition Assessment and Development of Optimum Replacement Methodology". Forensic Engineering 2012@ sGateway to a Safer Tomorrow. ASCE , 2012. 268-279. Print.
- Hu, Y., and DW Hubble. "Factors Contributing to the Failure of Asbestos Cement Water Mains." Canadian Journal of Civil Engineering 34.5 (2007): 608-21. Print.
- Hu, Yafei, et al. "AC Pipe in North America: Rehabilitation/Replacement Methods and Current Practices". Proceedings of the ASCE Annual Pipelines Conference: Infrastructure's Hidden Assets, San Diego, CA. 2009. Print.
- Hu, Yafei, Dunling Wang, and Rudaba Chowdhury. Guidance Manual for Managing Long Term Performance of Asbestos Cement Pipe., 2013. Print.
- Jarvis, B. "Asbestos-Cement Pipe corrosion—interim Report." Customer Services Division, Water Corporation, Western Australia, Australia (1998)Print.
- Kettler, AJ, and IC Goulter. "An Analysis of Pipe Breakage in Urban Water Distribution Networks." Canadian Journal of Civil Engineering 12.2 (1985): 286-93. Print.
- Mai, YW. "Strength and Fracture Properties of Asbestos-Cement Mortar Composites." Journal of Materials Science 14.9 (1979): 2091-102. Print.
- Millette, JR, and RN Kinman. "Iron-Containing Coatings on Asbestos-Cement Pipes Exposed to Aggressive Water." (1984)Print.
- Mordak, J., and J. Wheeler. "Deterioration of Asbestos Cement Water Mains." Final Report to the Department of the Environment (1988)Print.
- NAS (National Academy of Sciences) 1982 Drinking Water and Health, (vol. 4). National Academies Press, Washington, DC.
- Slaats, P., et al. "Tools to Monitor Corrosion of Cement-Containing Water Mains." Water Science & Technology 49.2 (2004): 33-9. Print.
- Wang, Dunling, Yafei Hu, and Rudaba Chowdhury. "Examination of Asbestos Cement Pipe Deterioration with Scanning Electron Microscopy". Pipelines Conference 2011. 2011. Print.
- Sullivan et al.: Water, In Drinking. "Public Health Goal for Chemicals in Drinking Water." (2003)Print.

Zivica, Vladimír, and Adolf Bajza. "Acidic Attack of Cement Based materials—a Review.: Part 1. Principle of Acidic Attack." *Construction and Building Materials* 15.8 (2001): 331-40. Print.